

Схема радиотелефона PANASONIC KX-T9280-BX, KX-T9280-LA

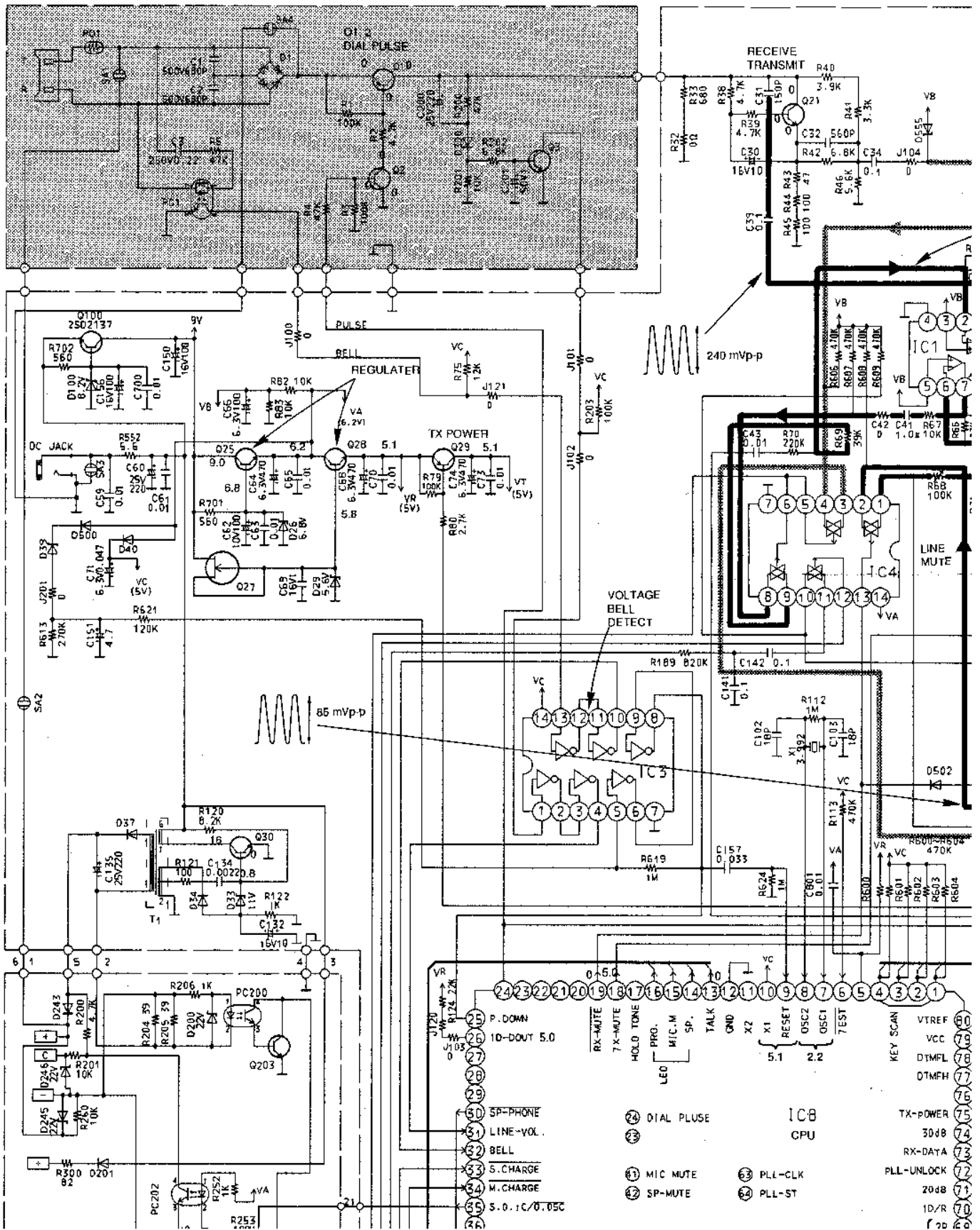

10Vp-p

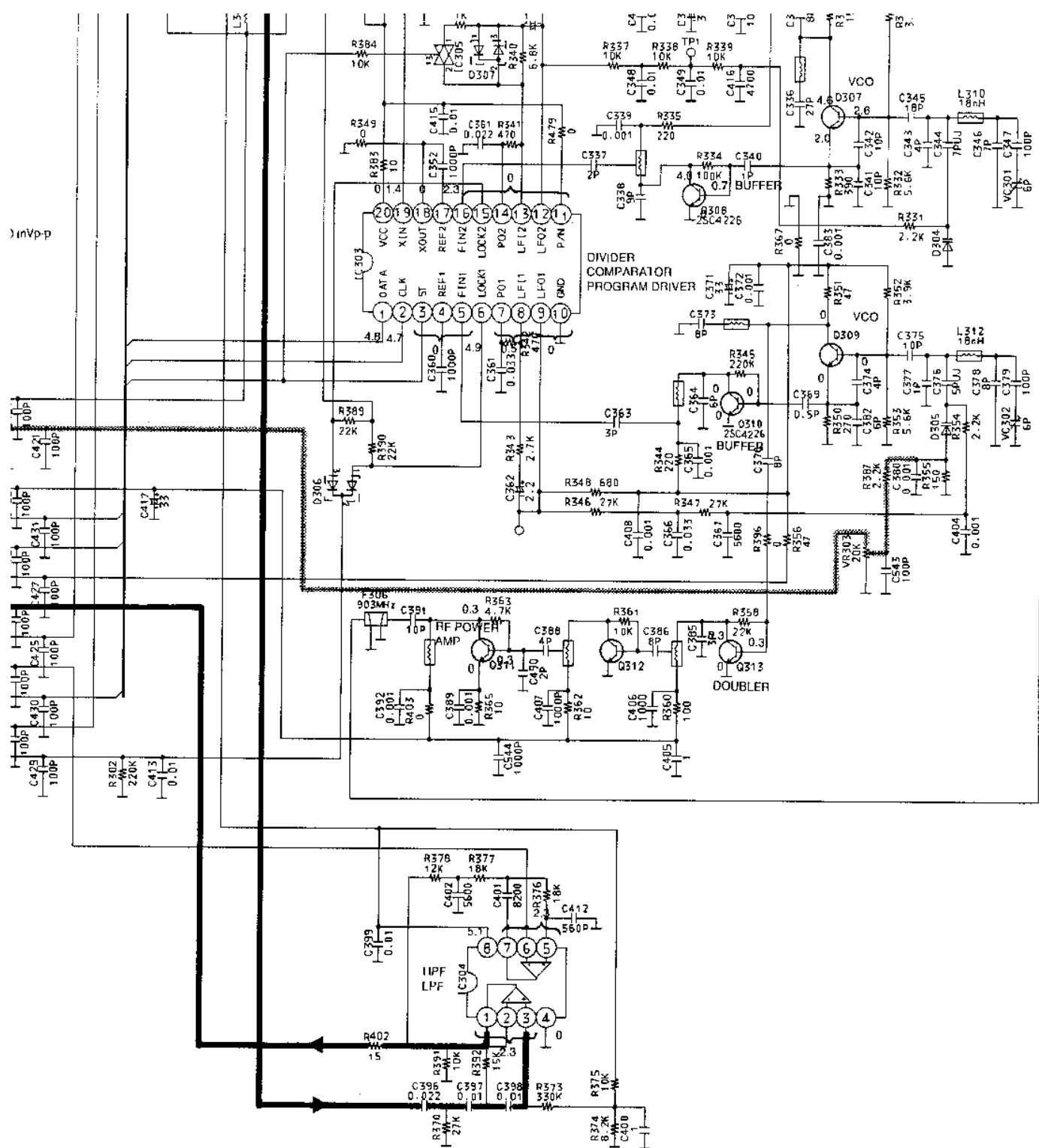

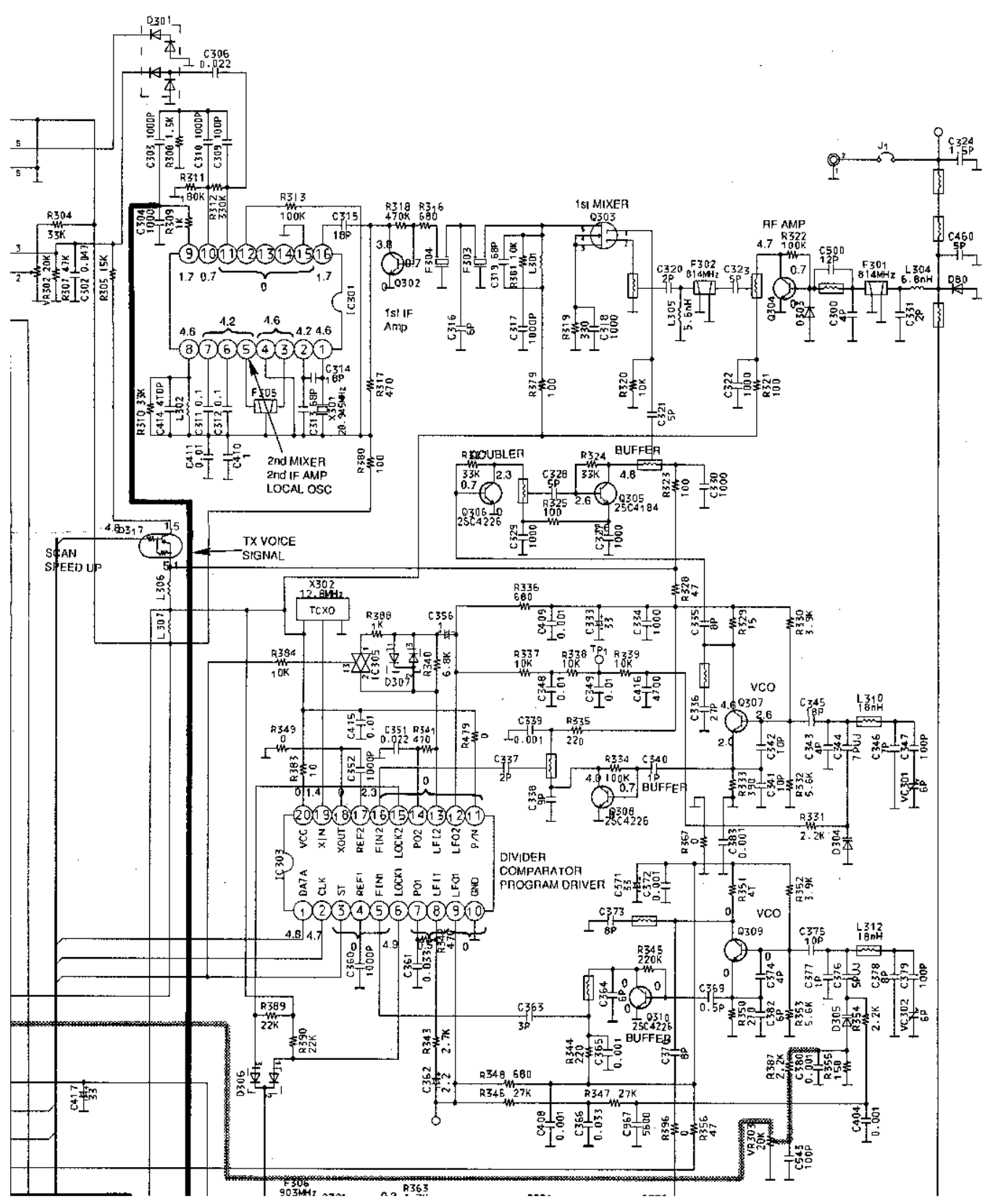

903MHz ... R363

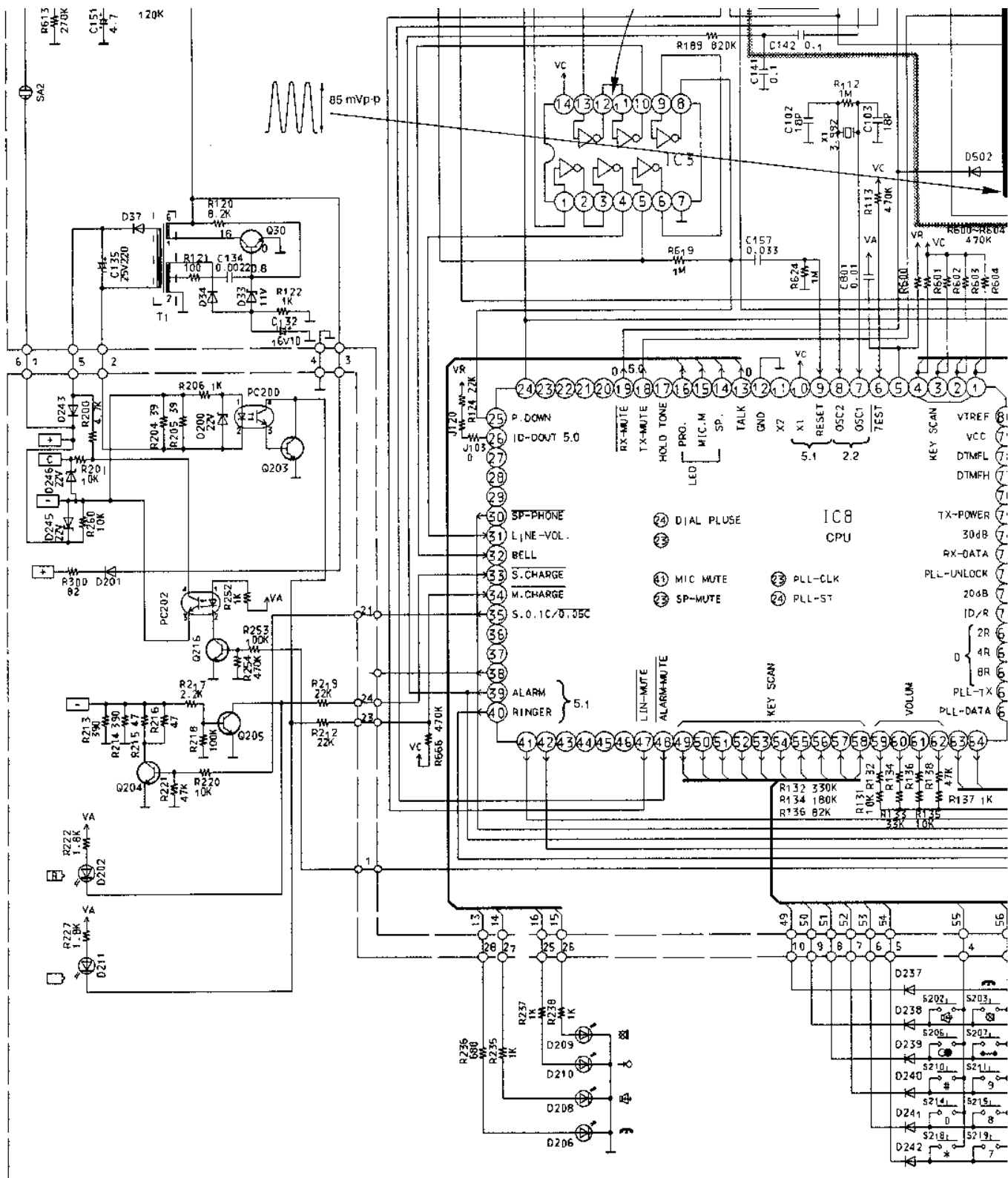

85 mVp-p

- IC8 CPU**
- ① MIC MUTE
 - ② SP-MUTE
 - ③ DIAL PULSE
 - ④ PLL-CLK
 - ⑤ PLL-ST
 - ⑥ TX-POWER 30dB
 - ⑦ RX-DATA
 - ⑧ PLL-UNLOCK
 - ⑨ 20dB
 - ⑩ ID/R
 - ⑪ 2R
 - ⑫ D
 - ⑬ 8R
 - ⑭ PLL-TX
 - ⑮ PLL-DATA

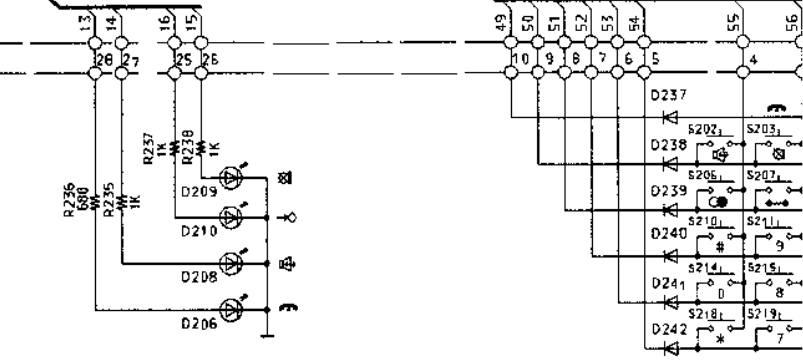

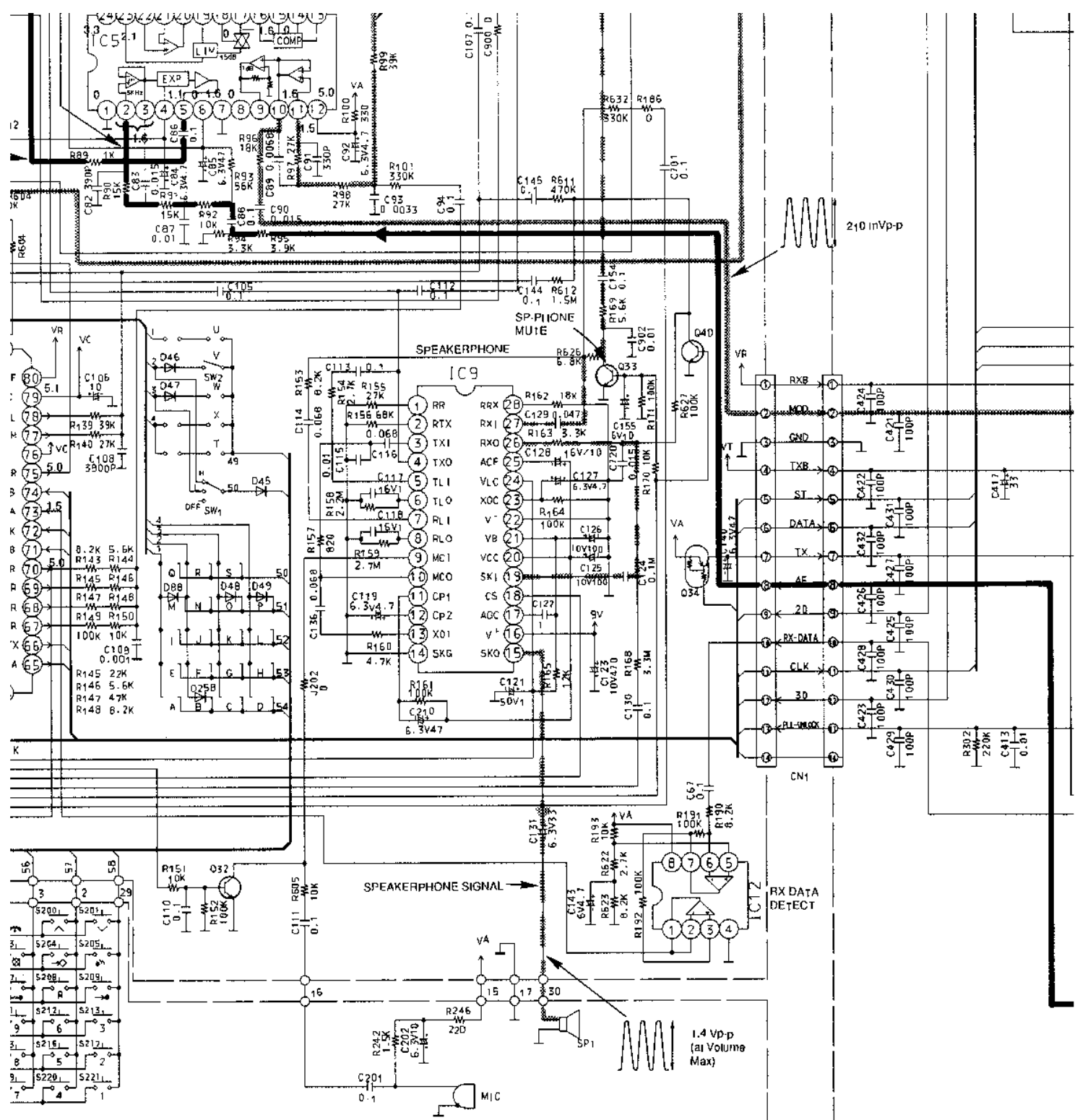

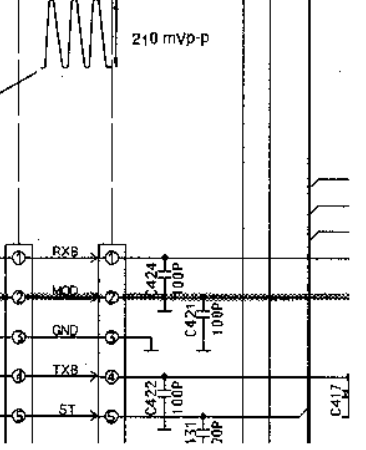
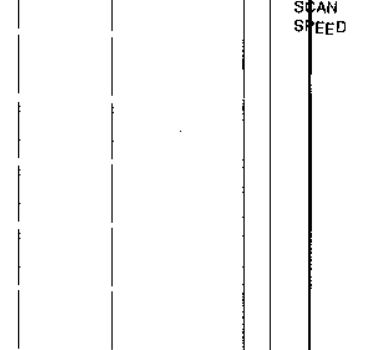
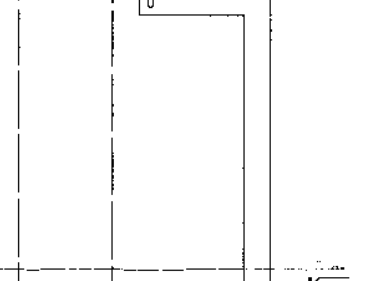
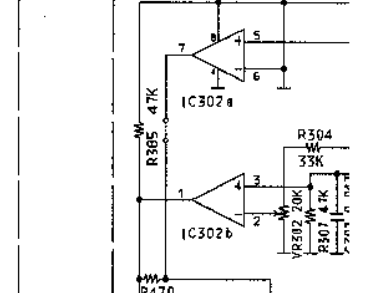
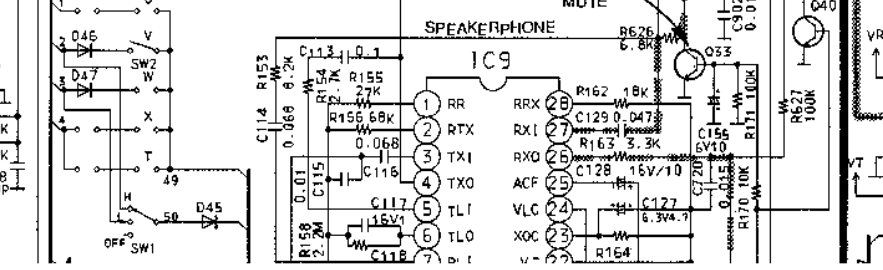
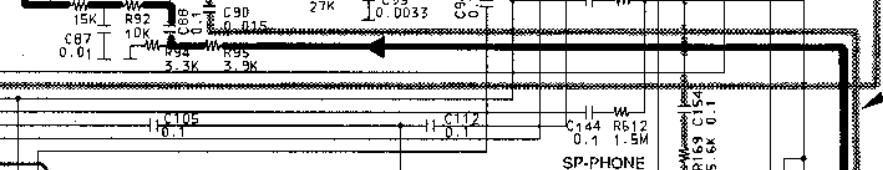
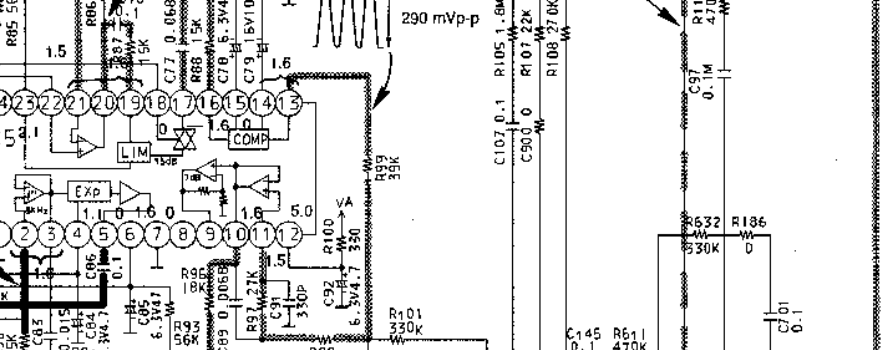
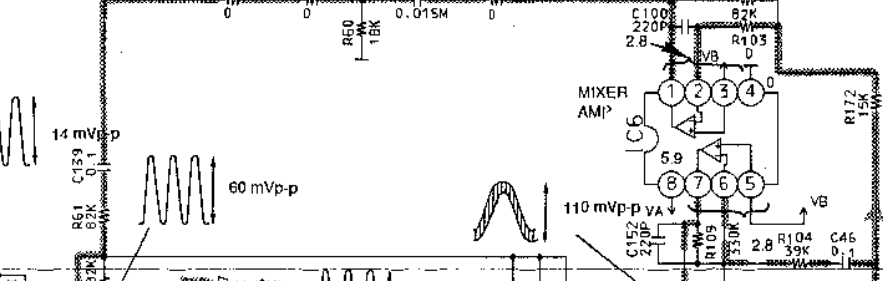
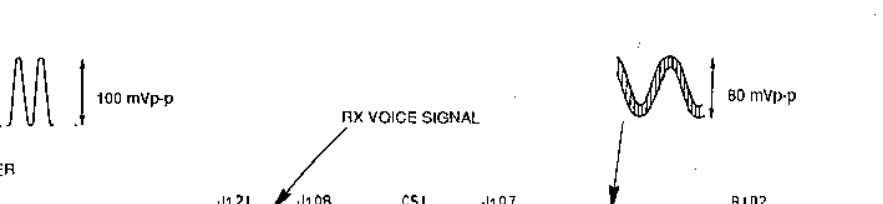
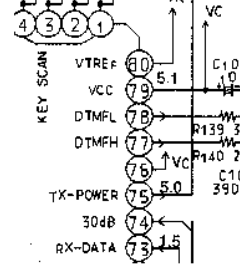
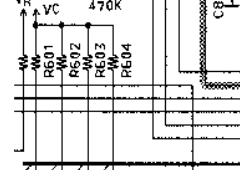
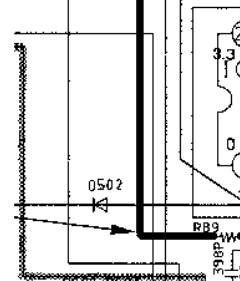
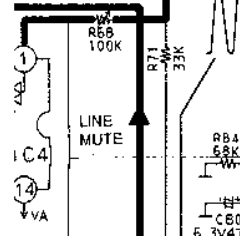
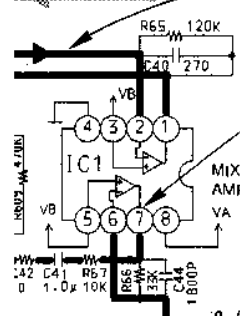
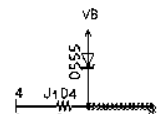
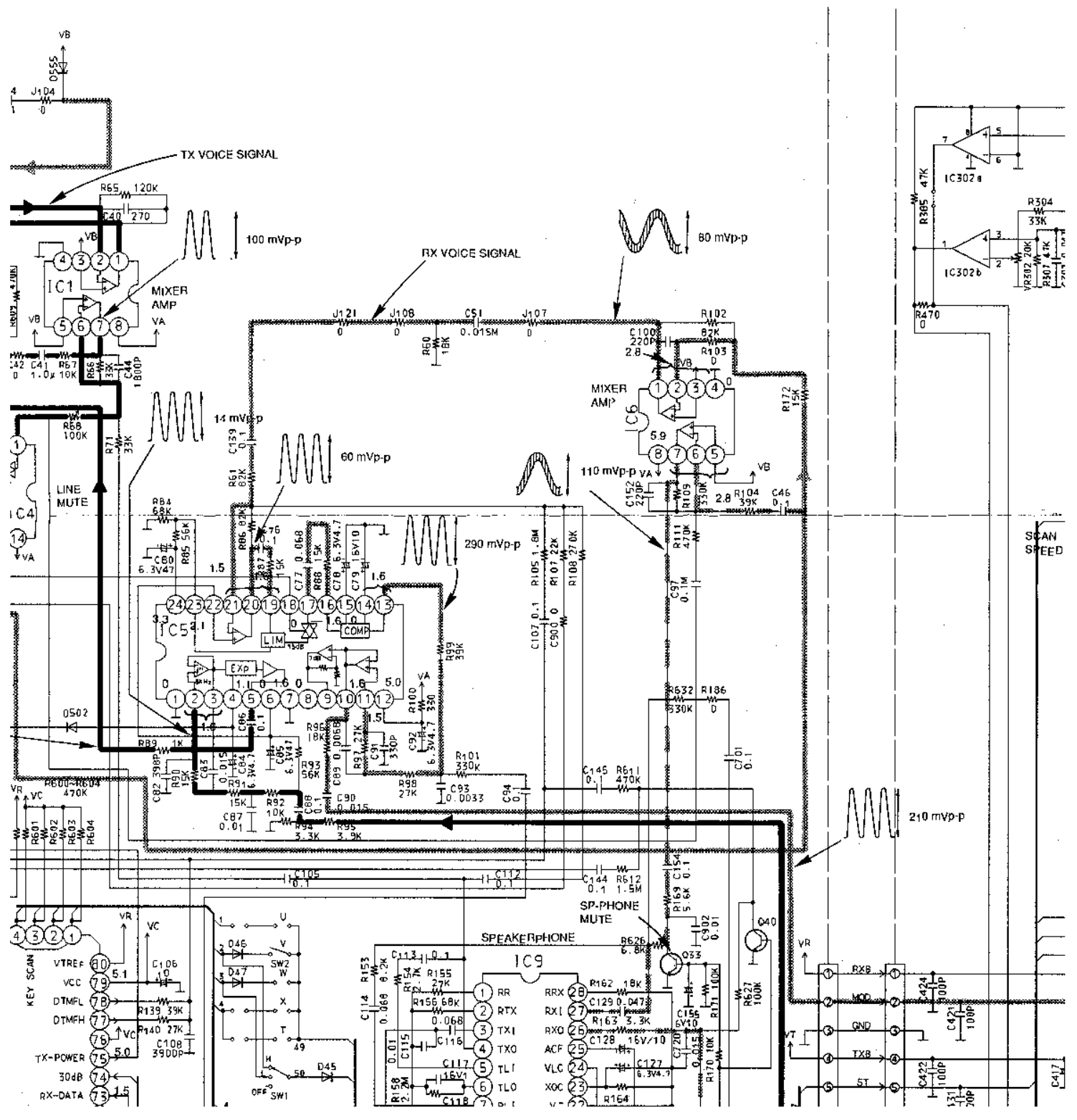

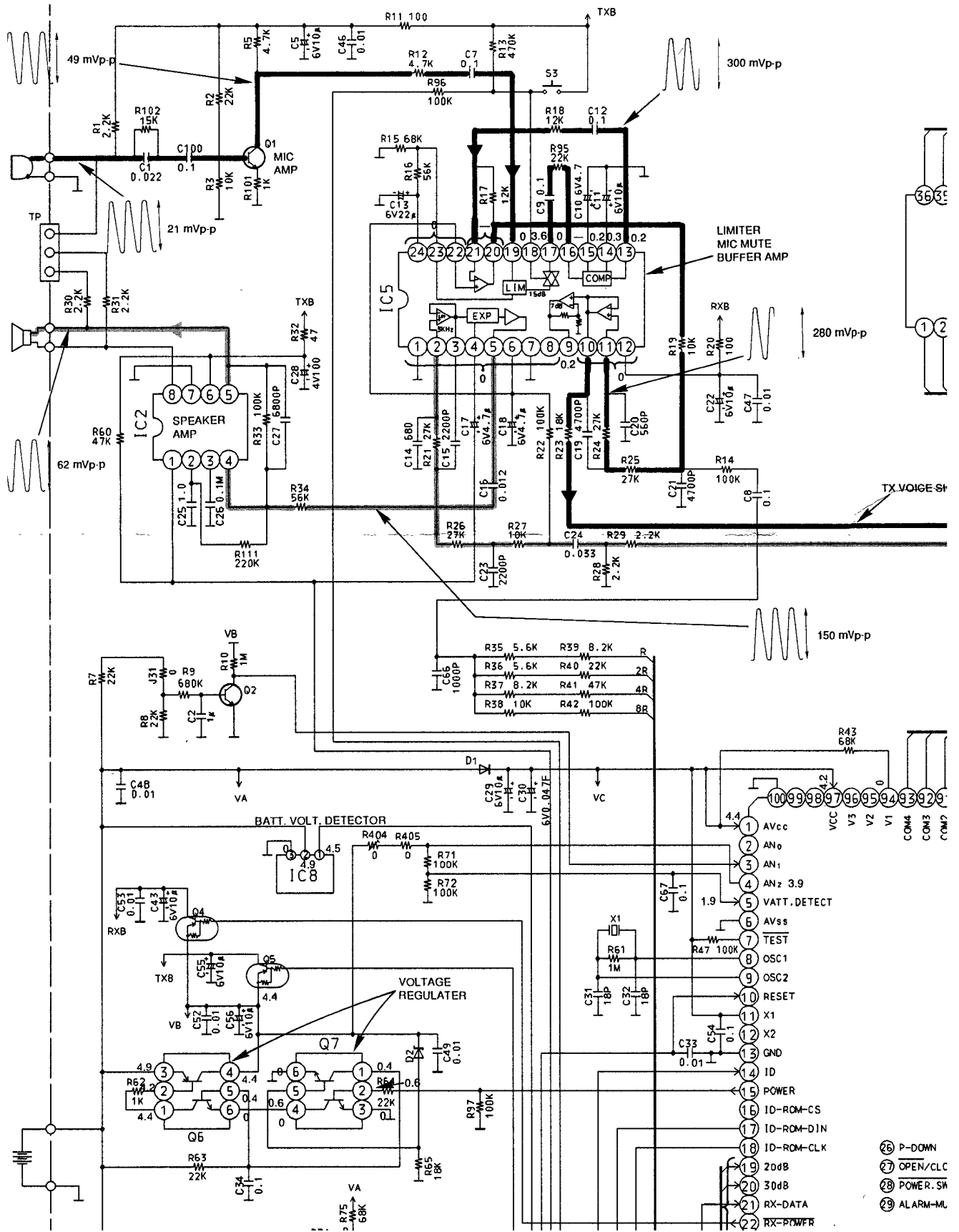

- ②⑤ P-DOWN
- ⑦ OPEN/CLC
- ⑲ POWER-SW
- ⑳ ALARM-ML

