

Схема радиотелефона PANASONIC KX-TC908-BX

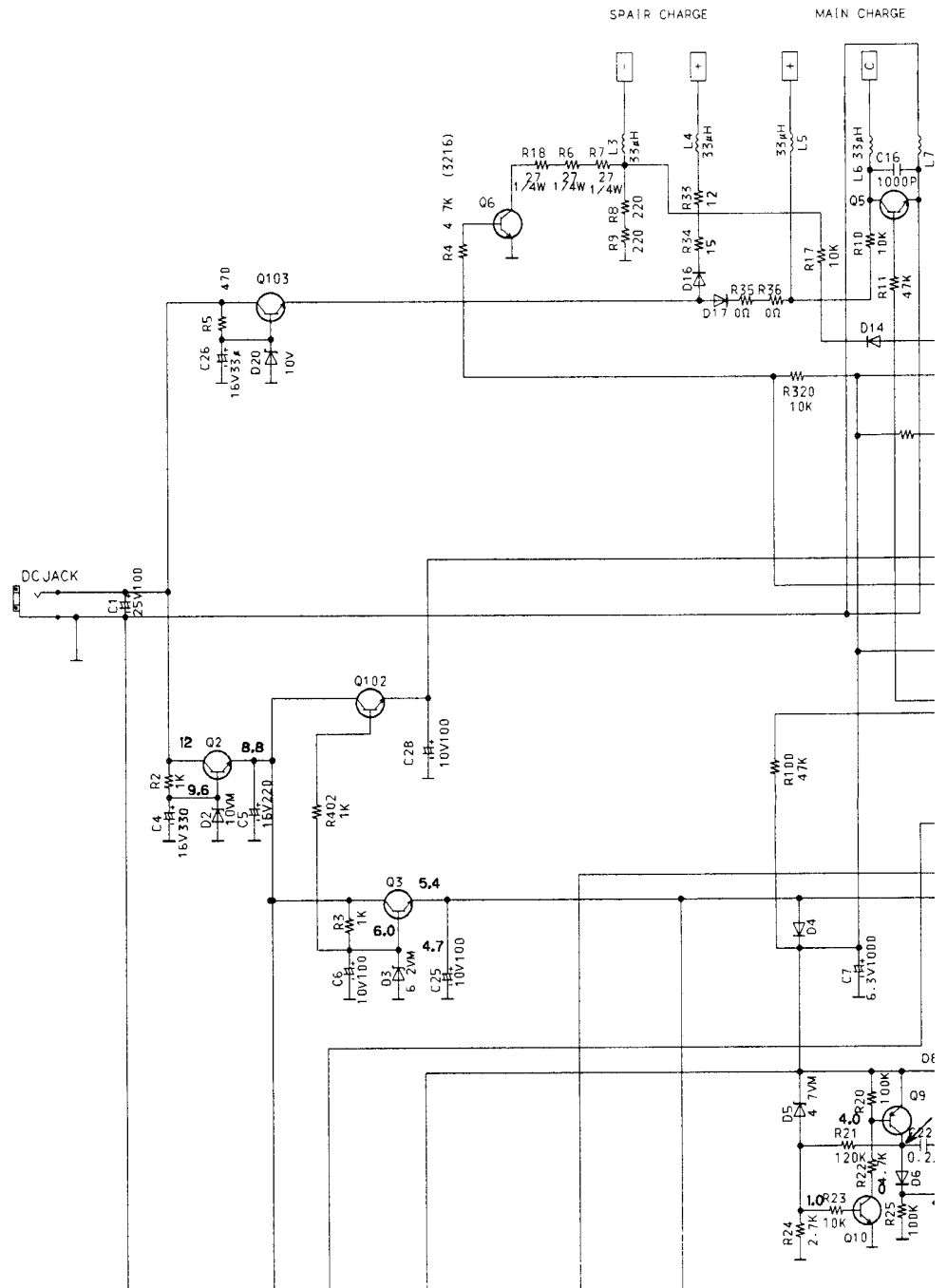

UNIT)

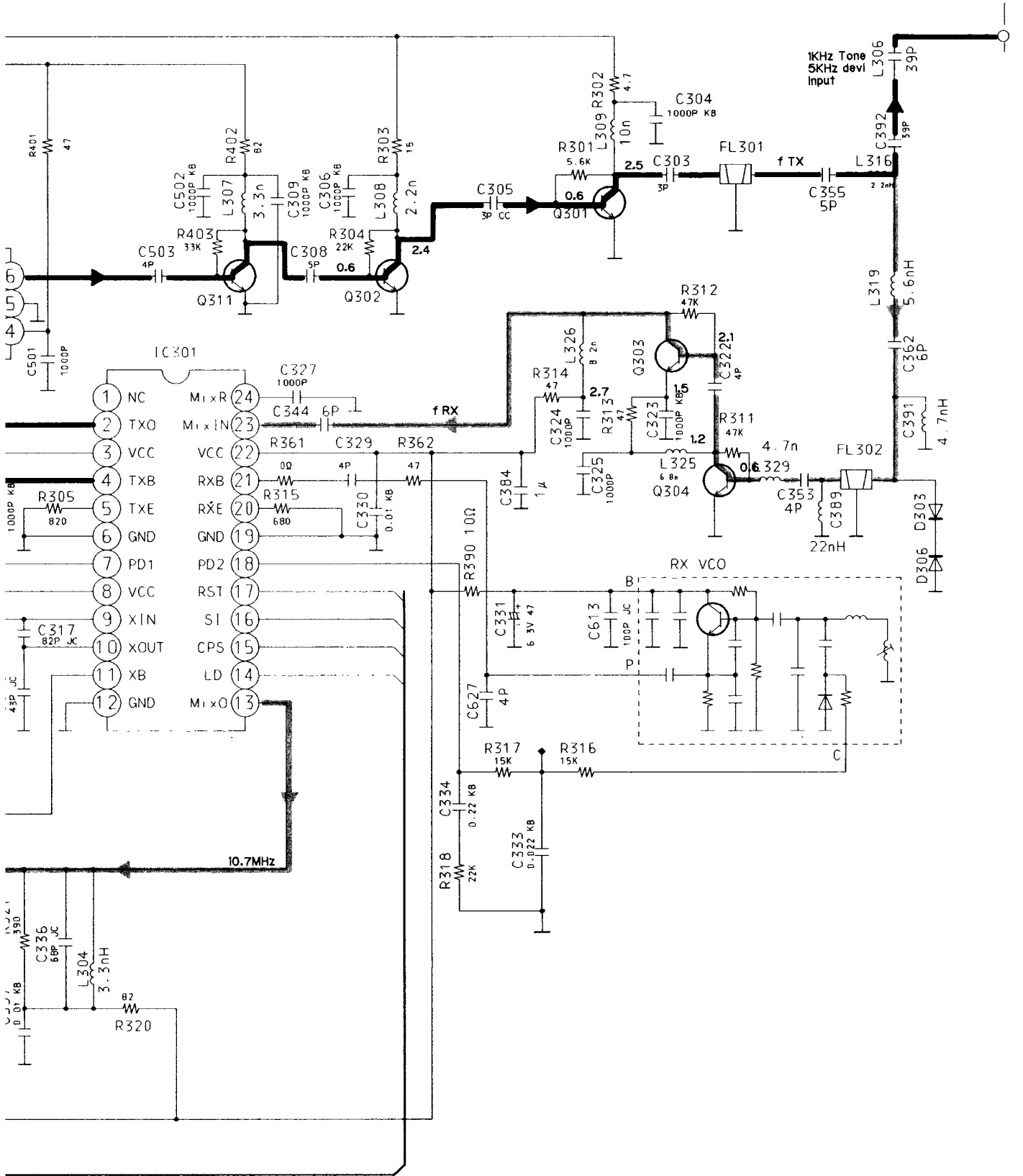

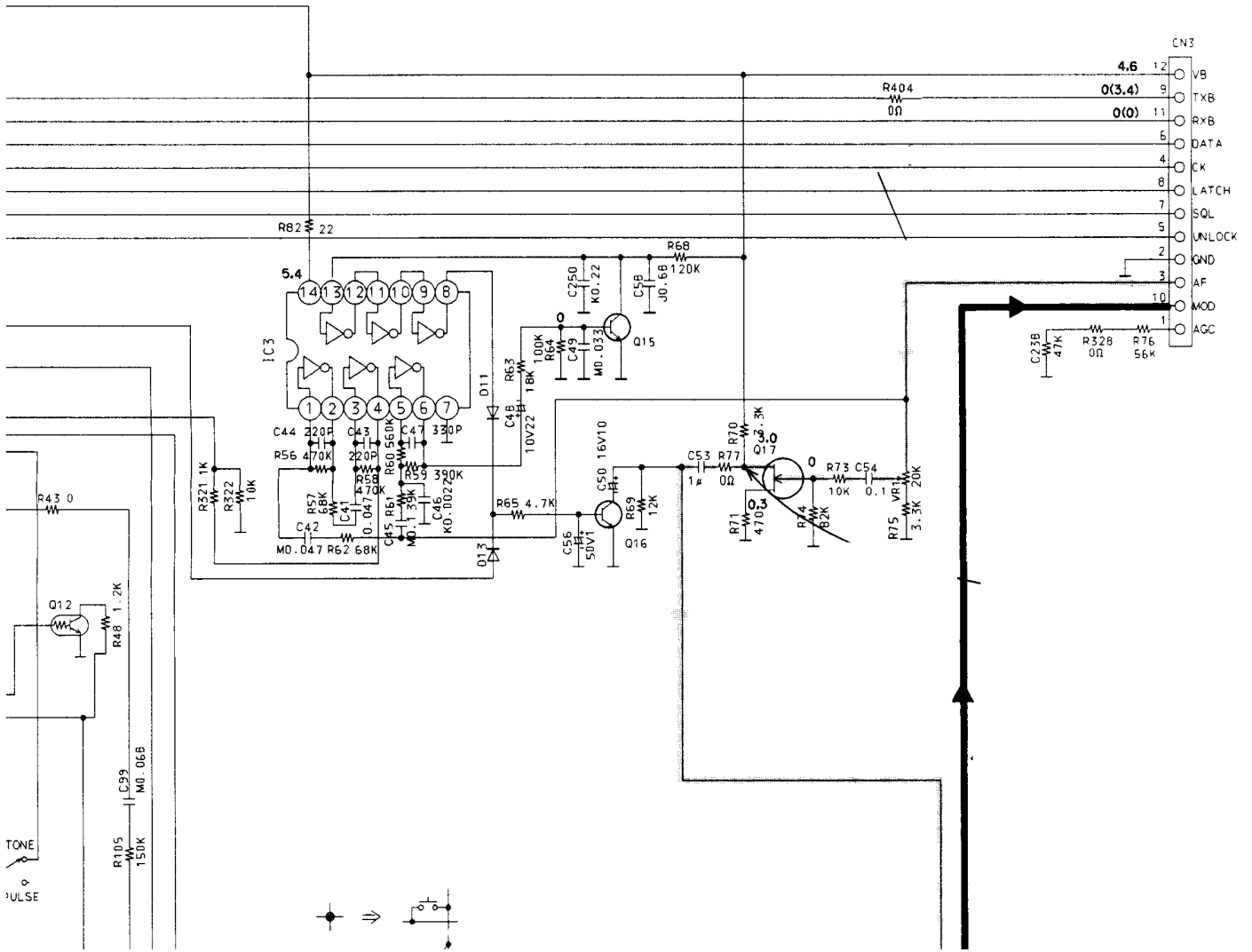

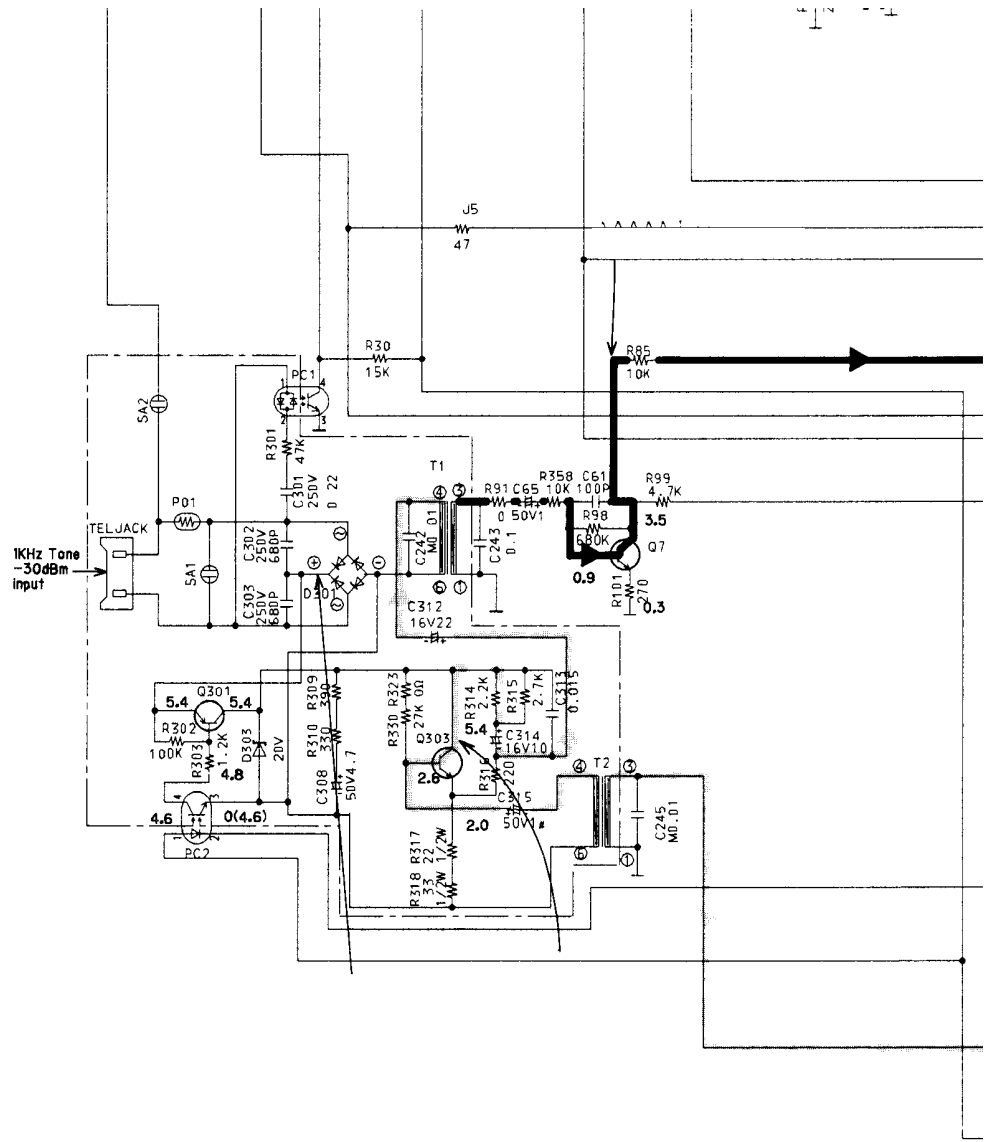

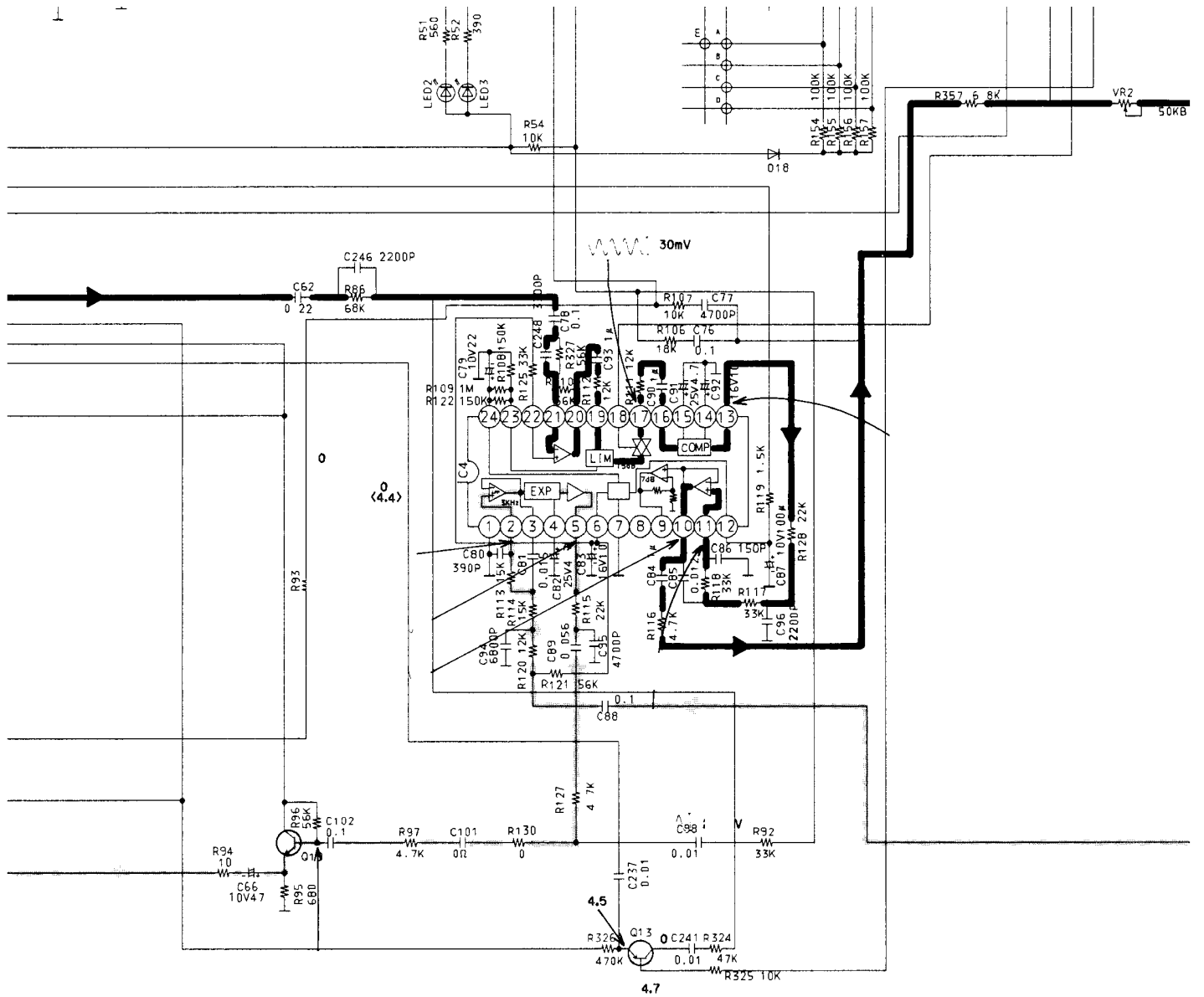

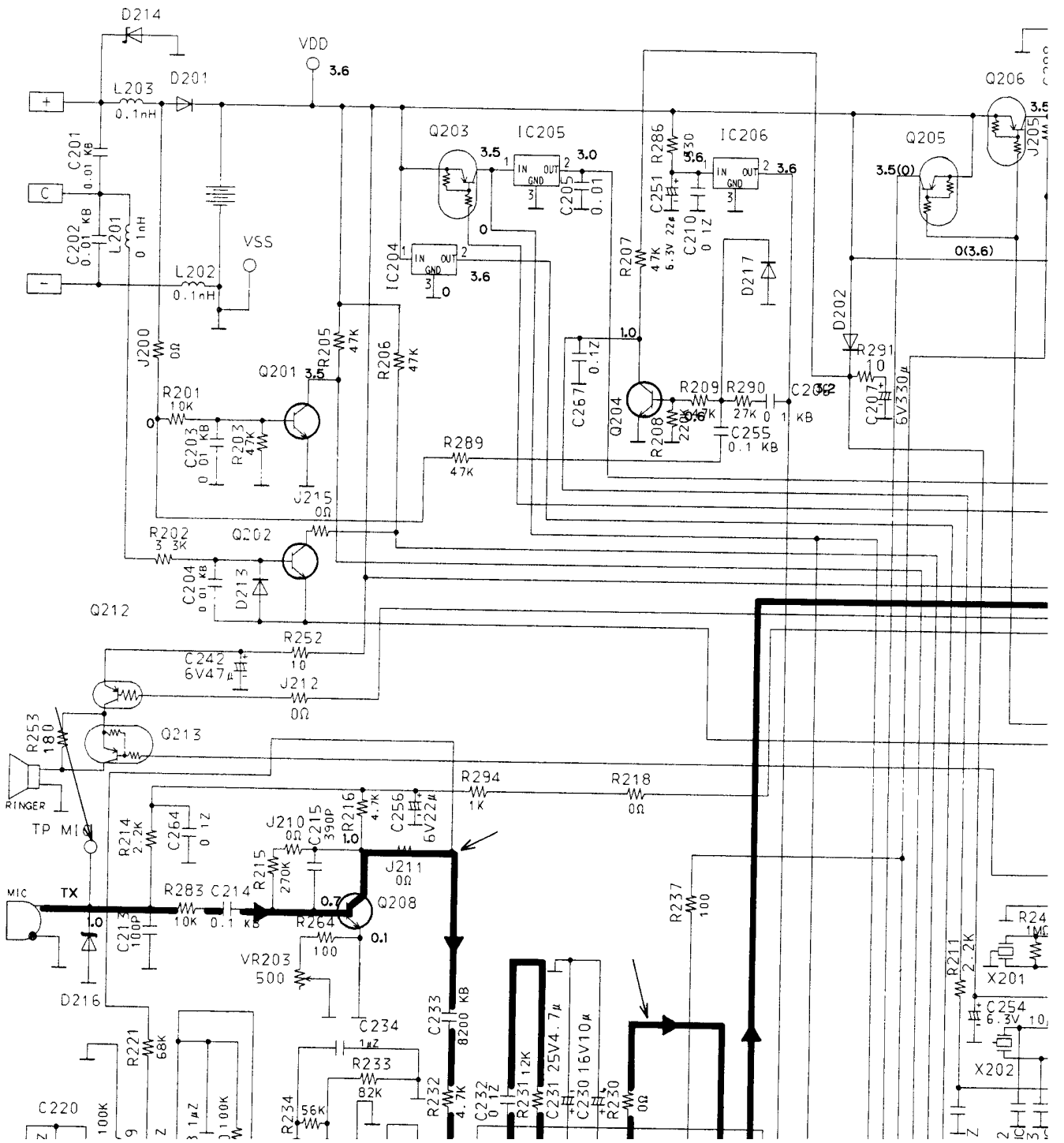

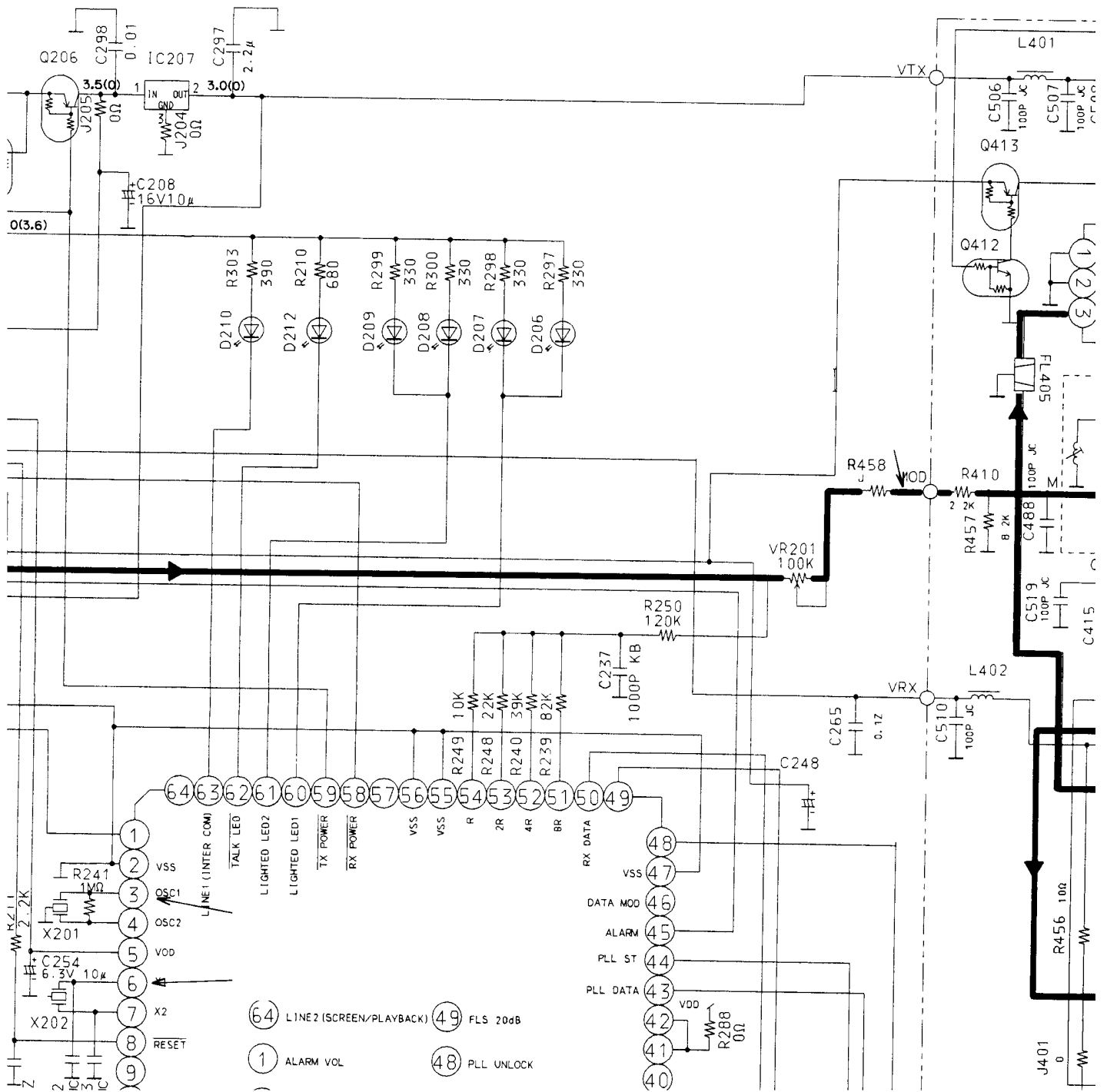

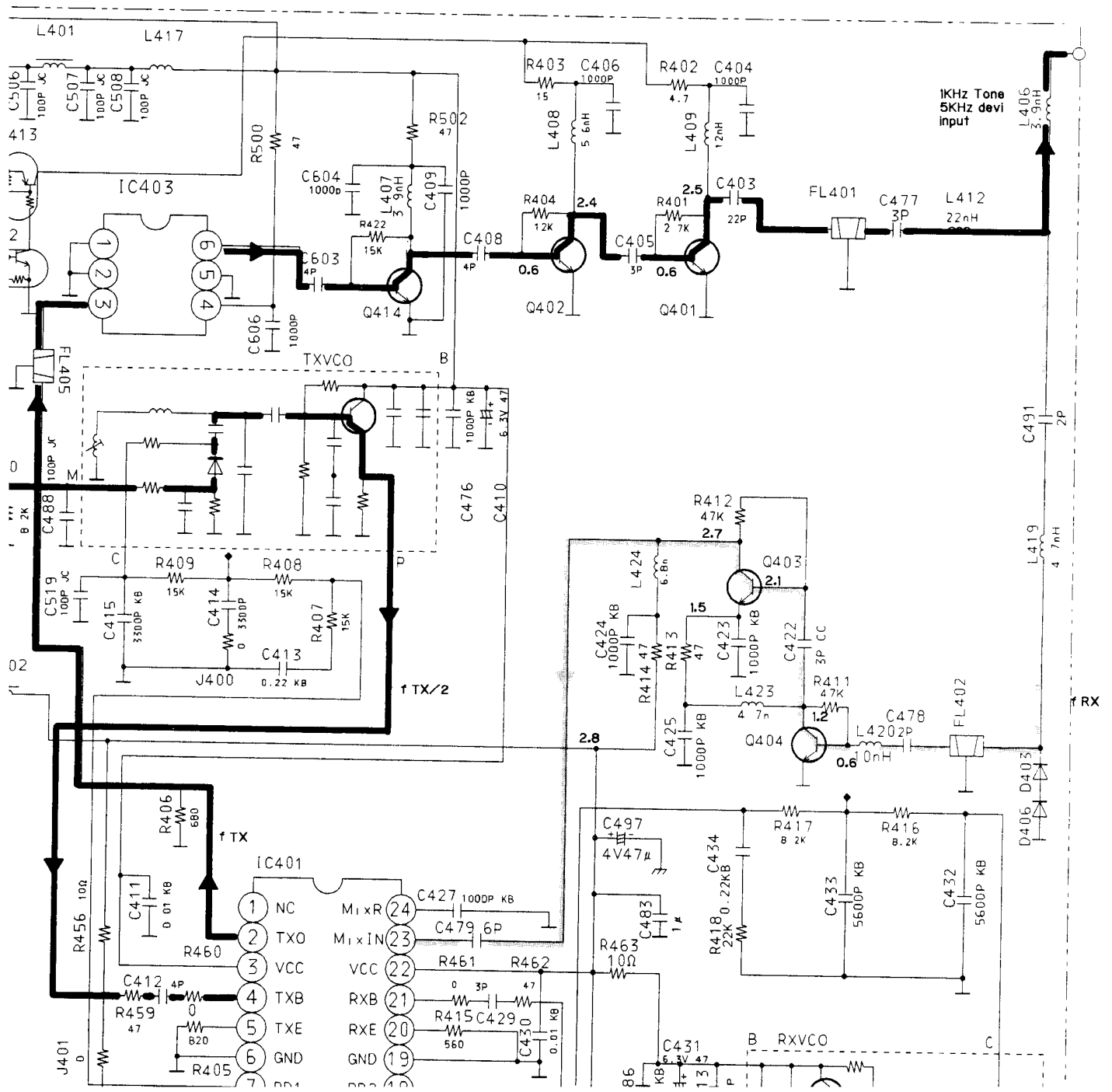

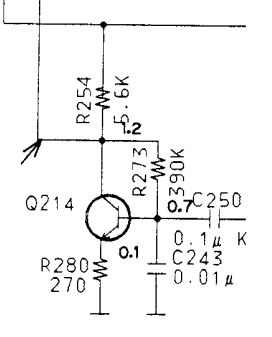
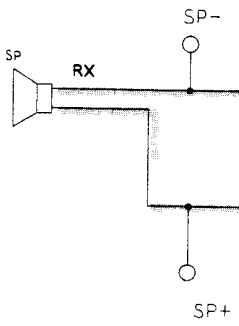
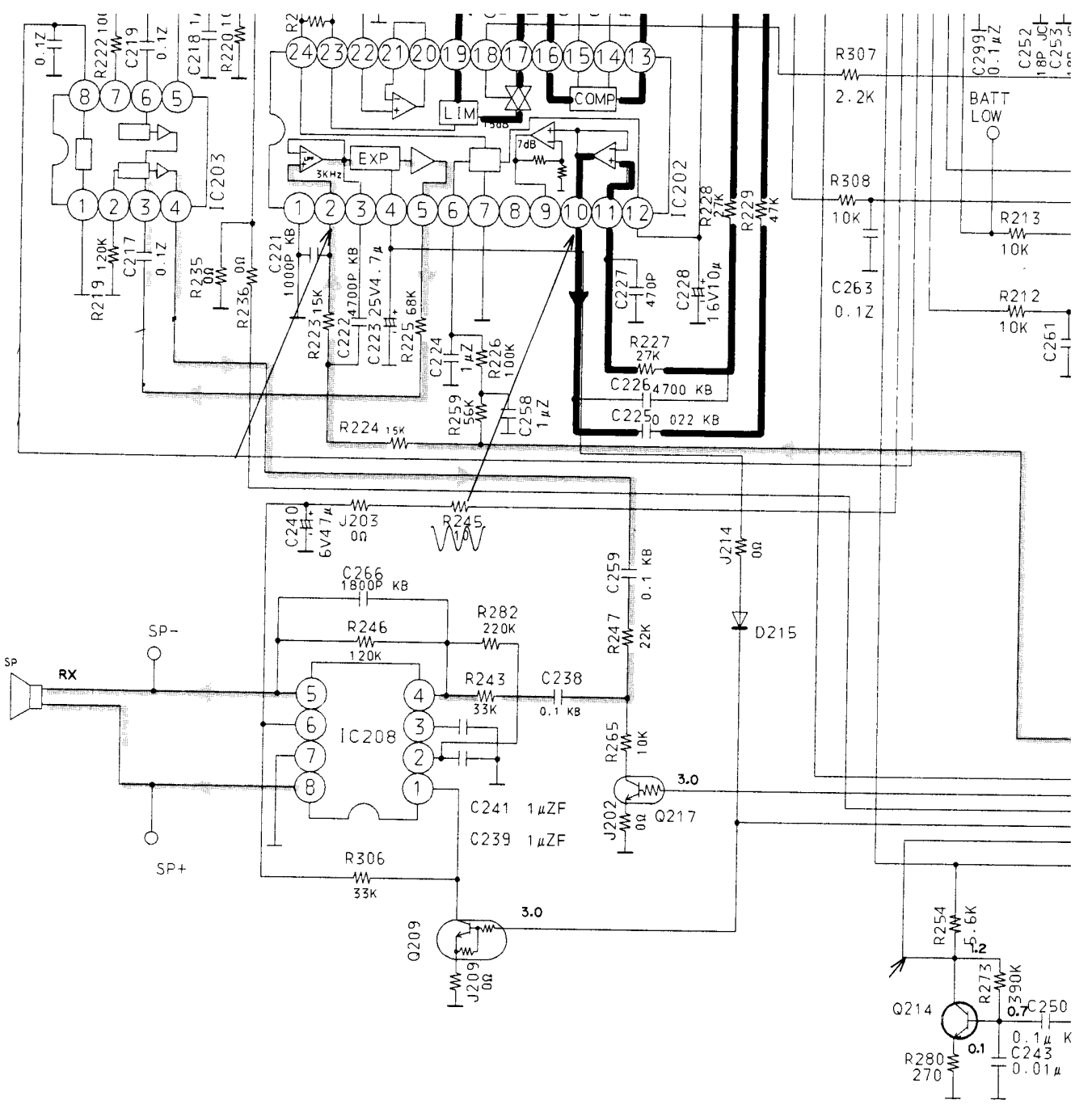

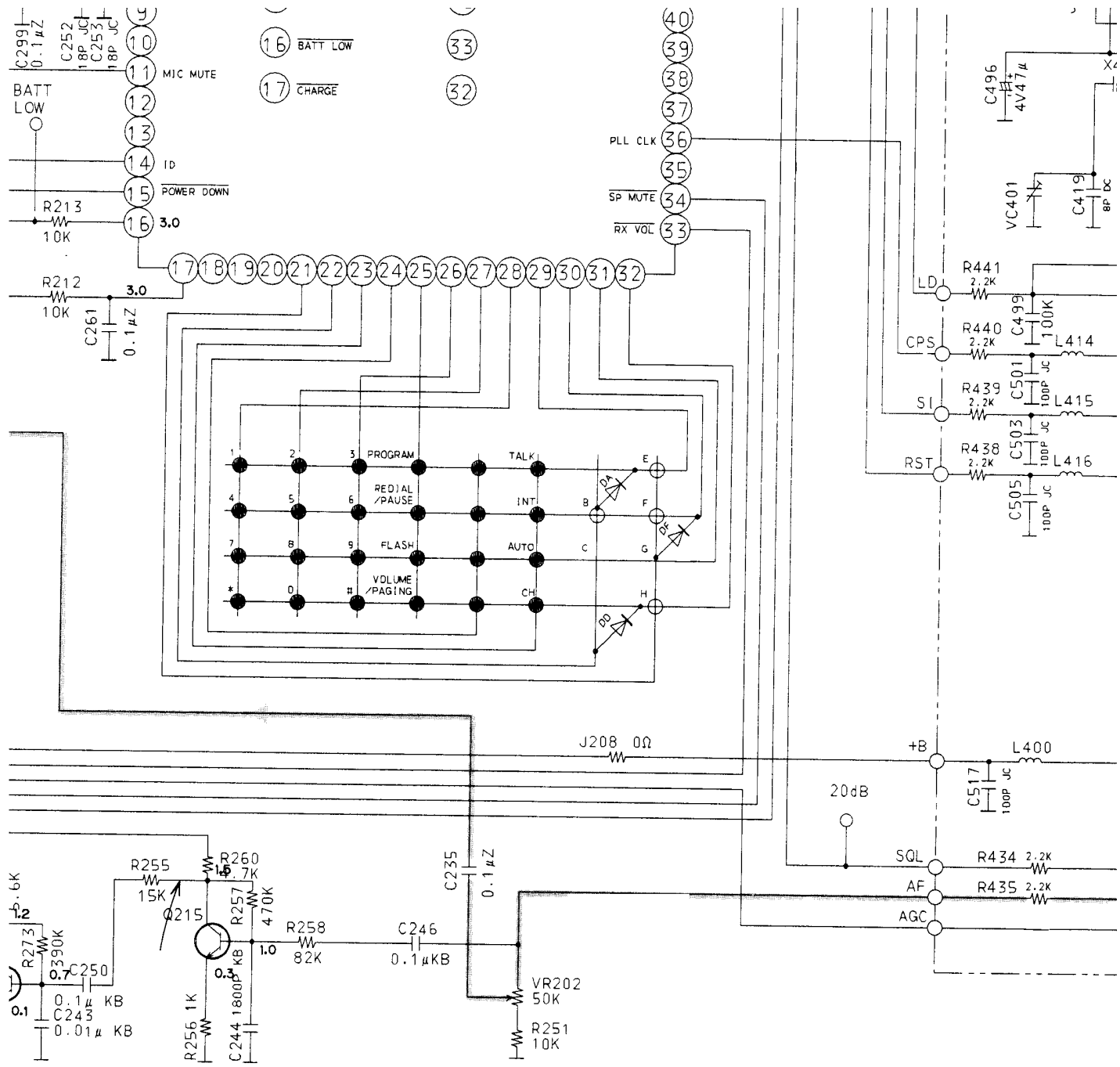

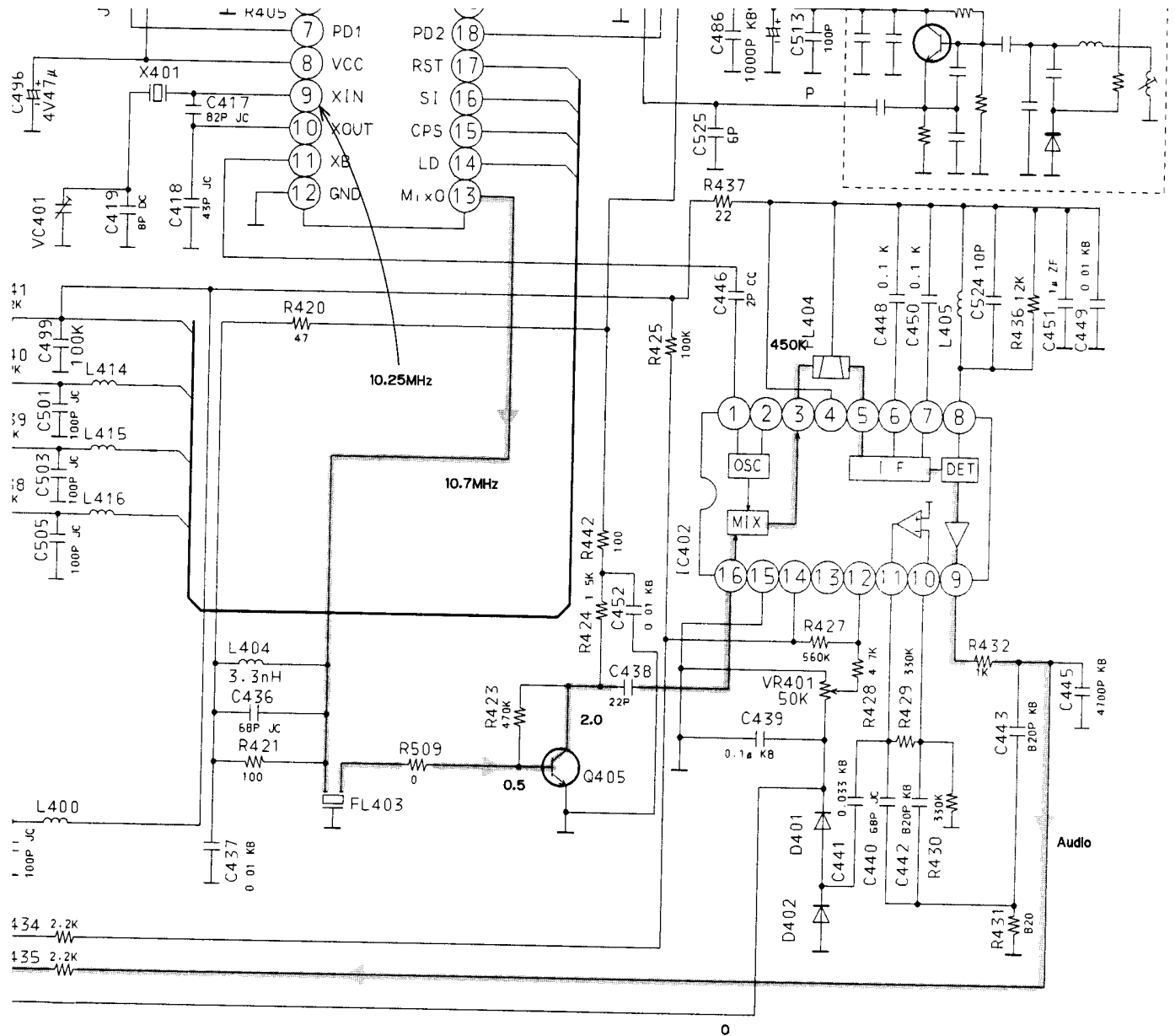

(RF UNIT)

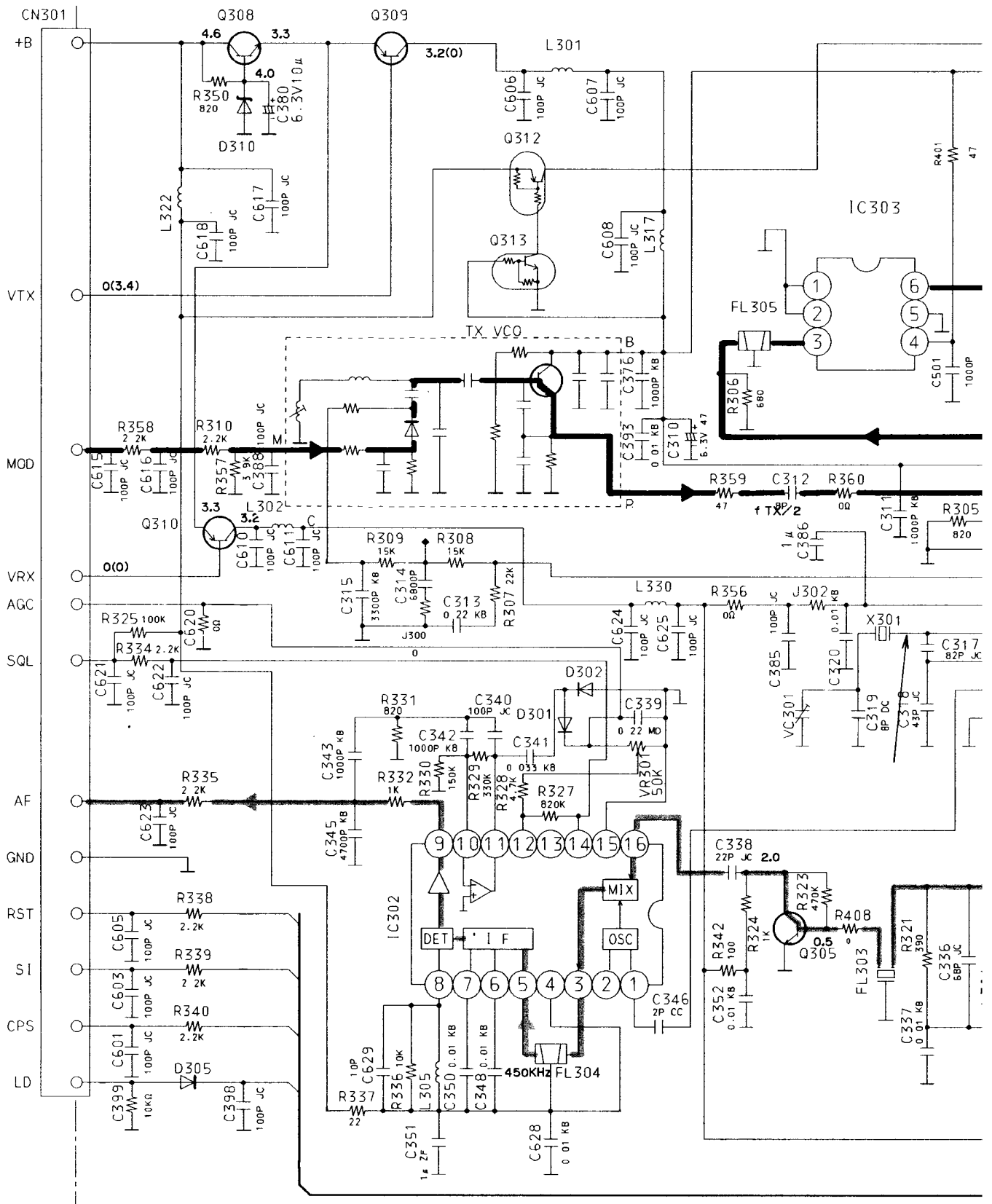

MAIN CHARGE

