

Схема радиотелефона PANASONIC KX-TC928-BX

(RF UNIT)

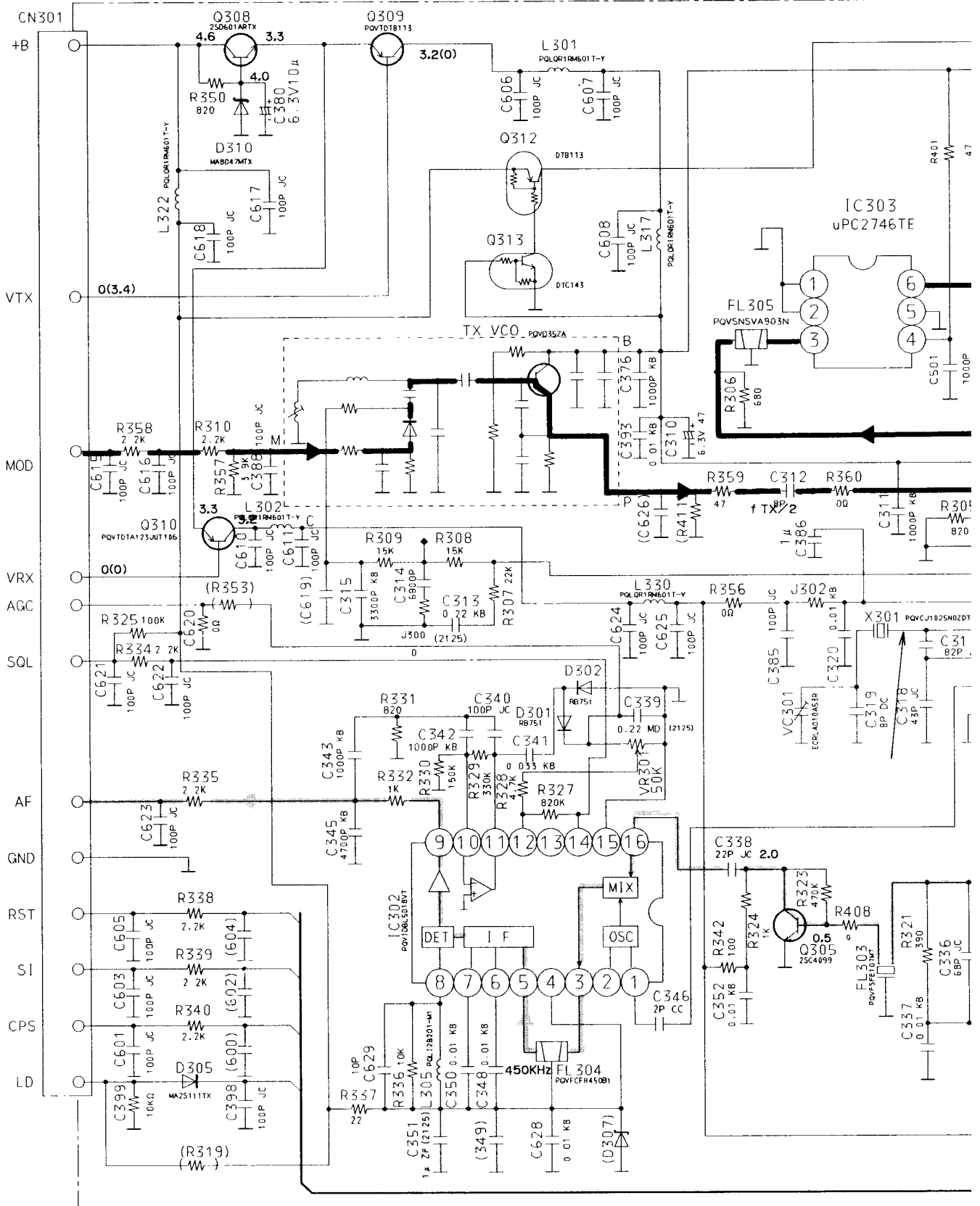

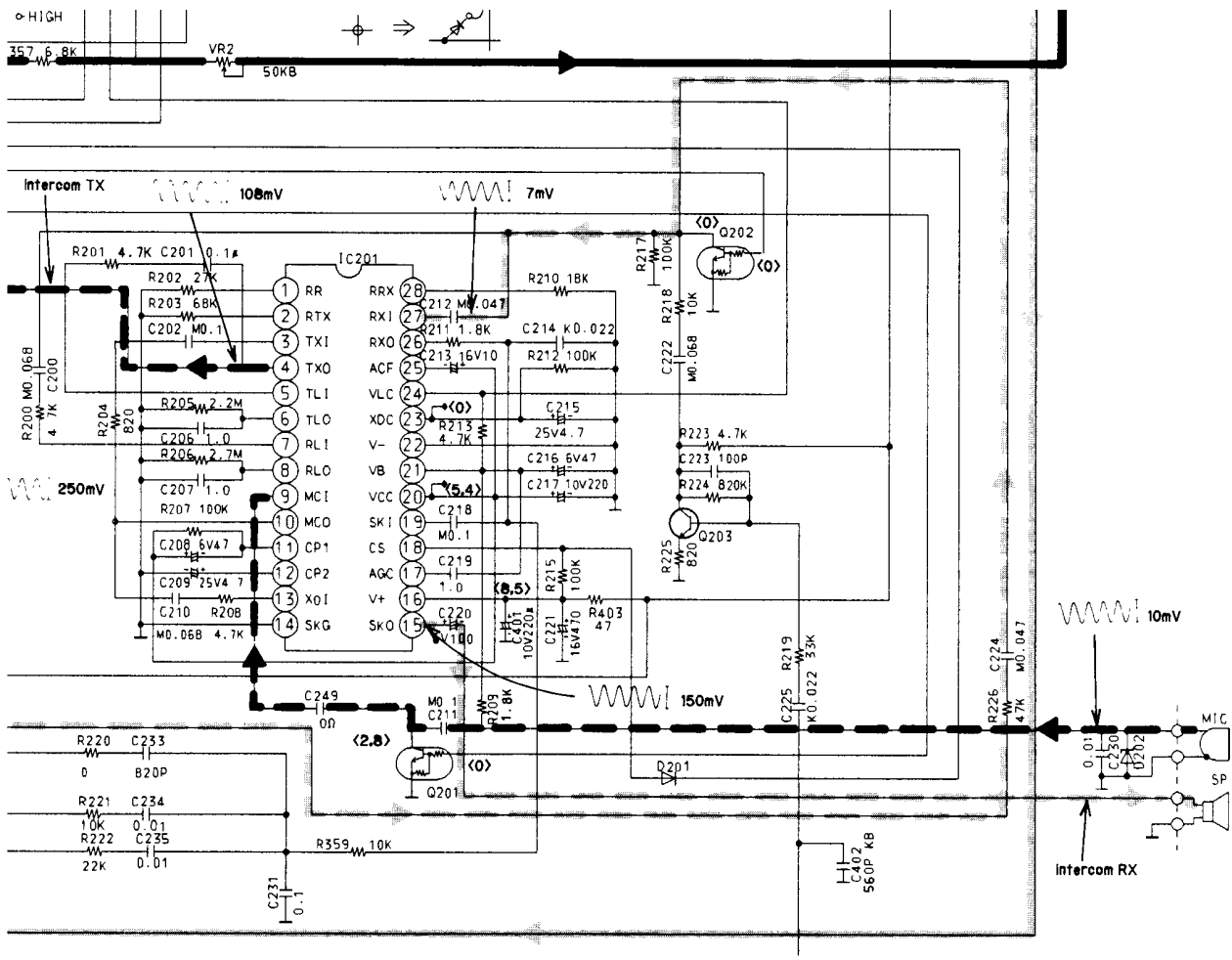

o-HIGH

357 8K VR2 50KB

Intercom TX

108mV

7mV

250mV

150mV

10mV

Intercom RX

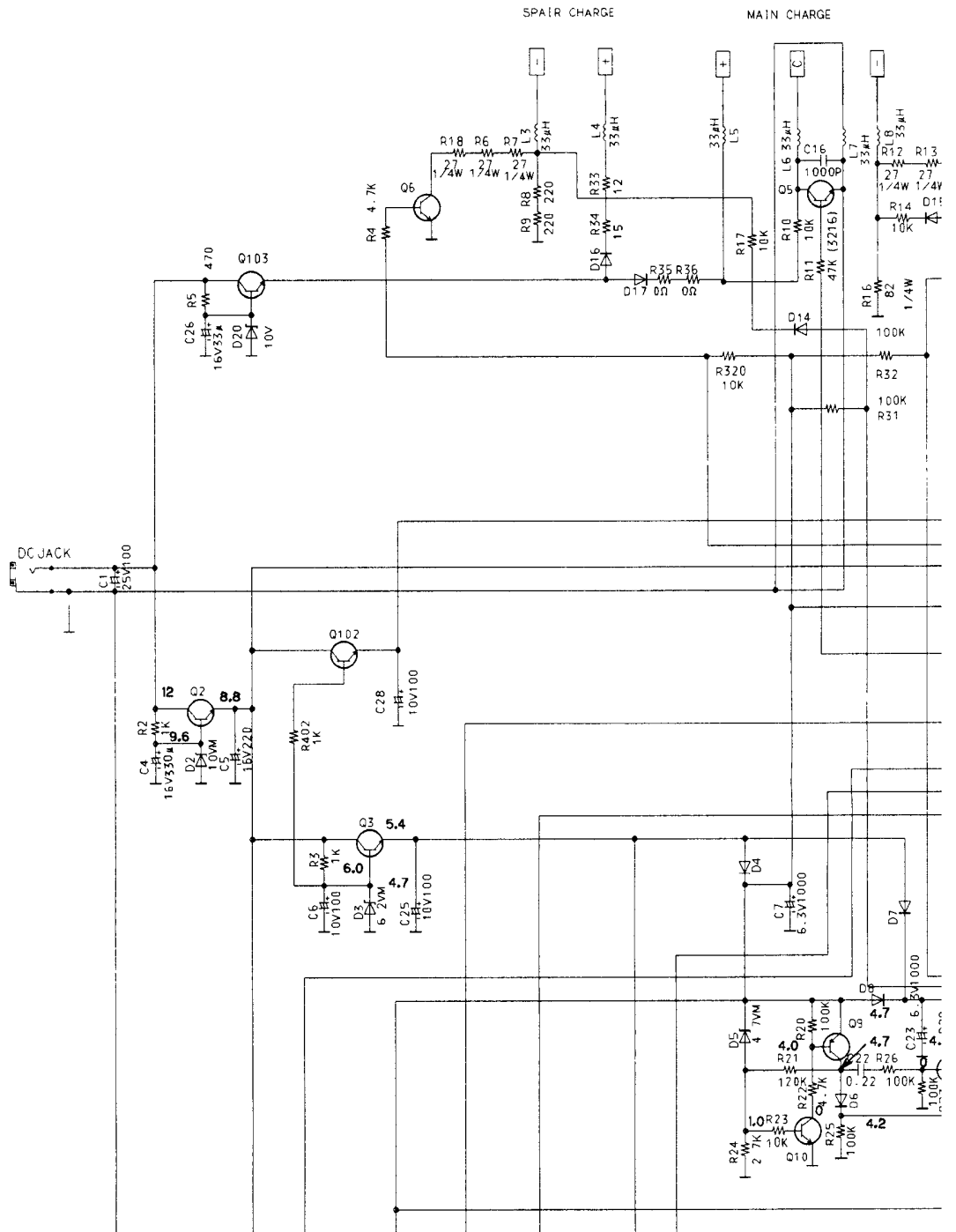

MAIN CHARGE

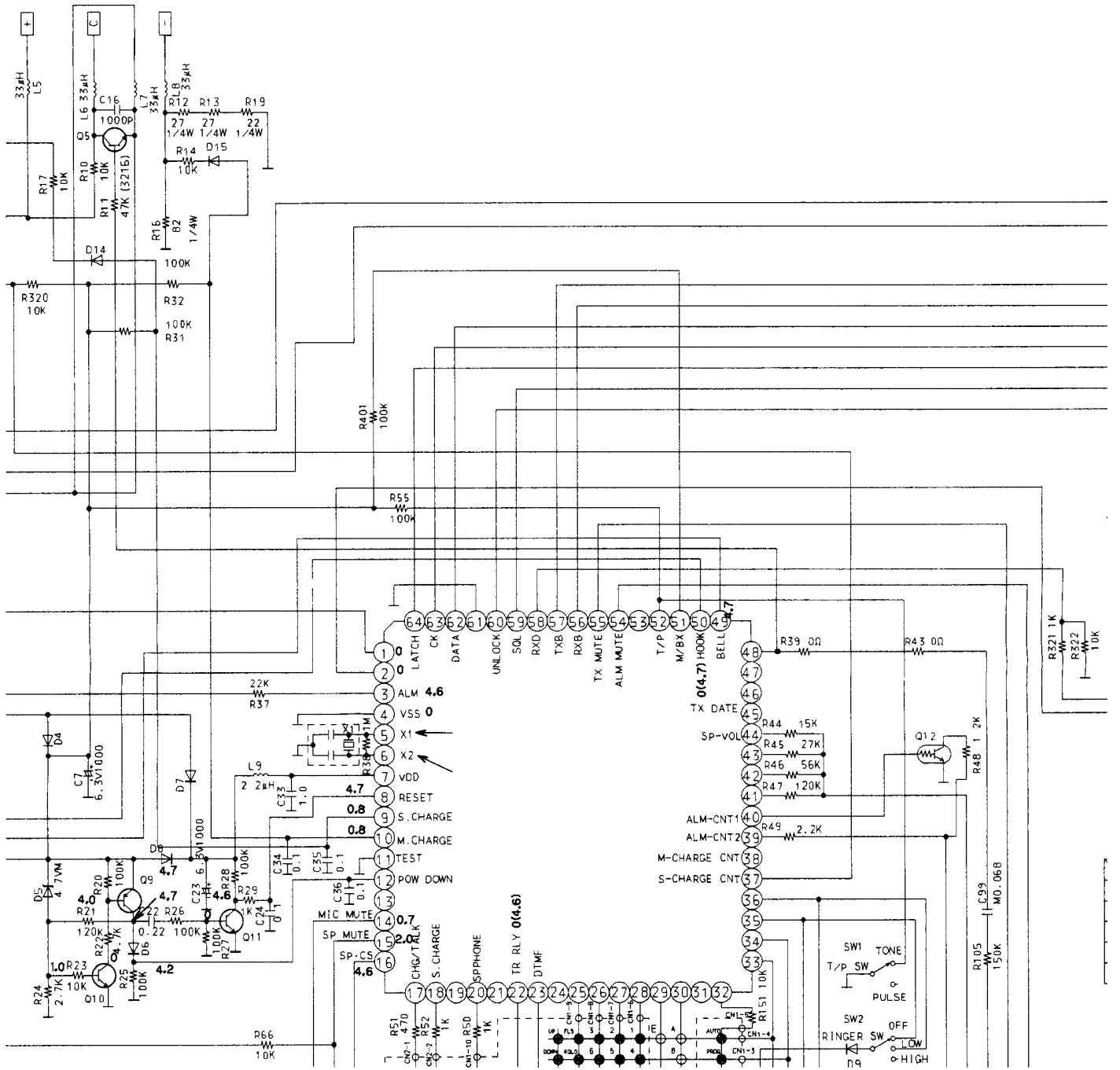

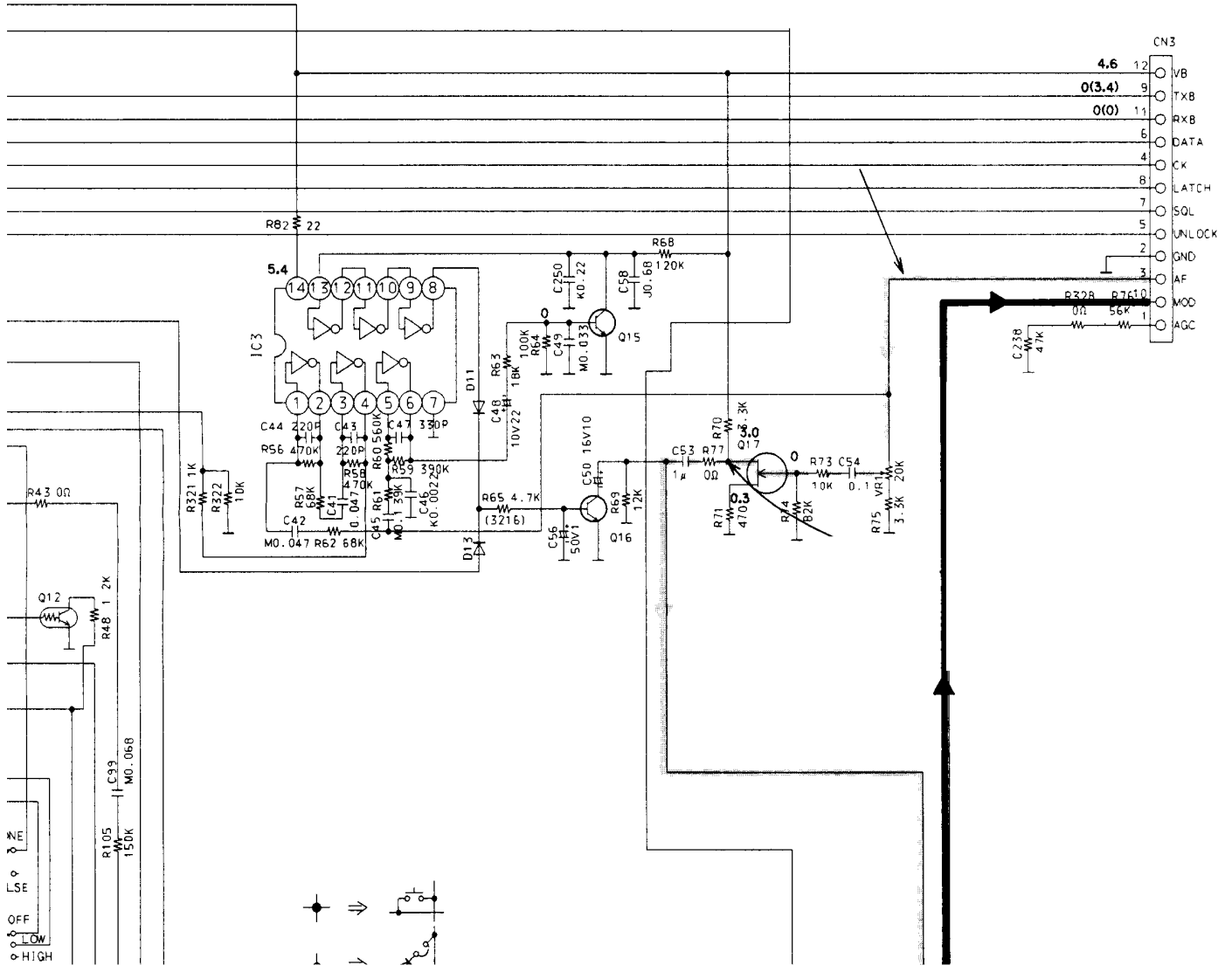

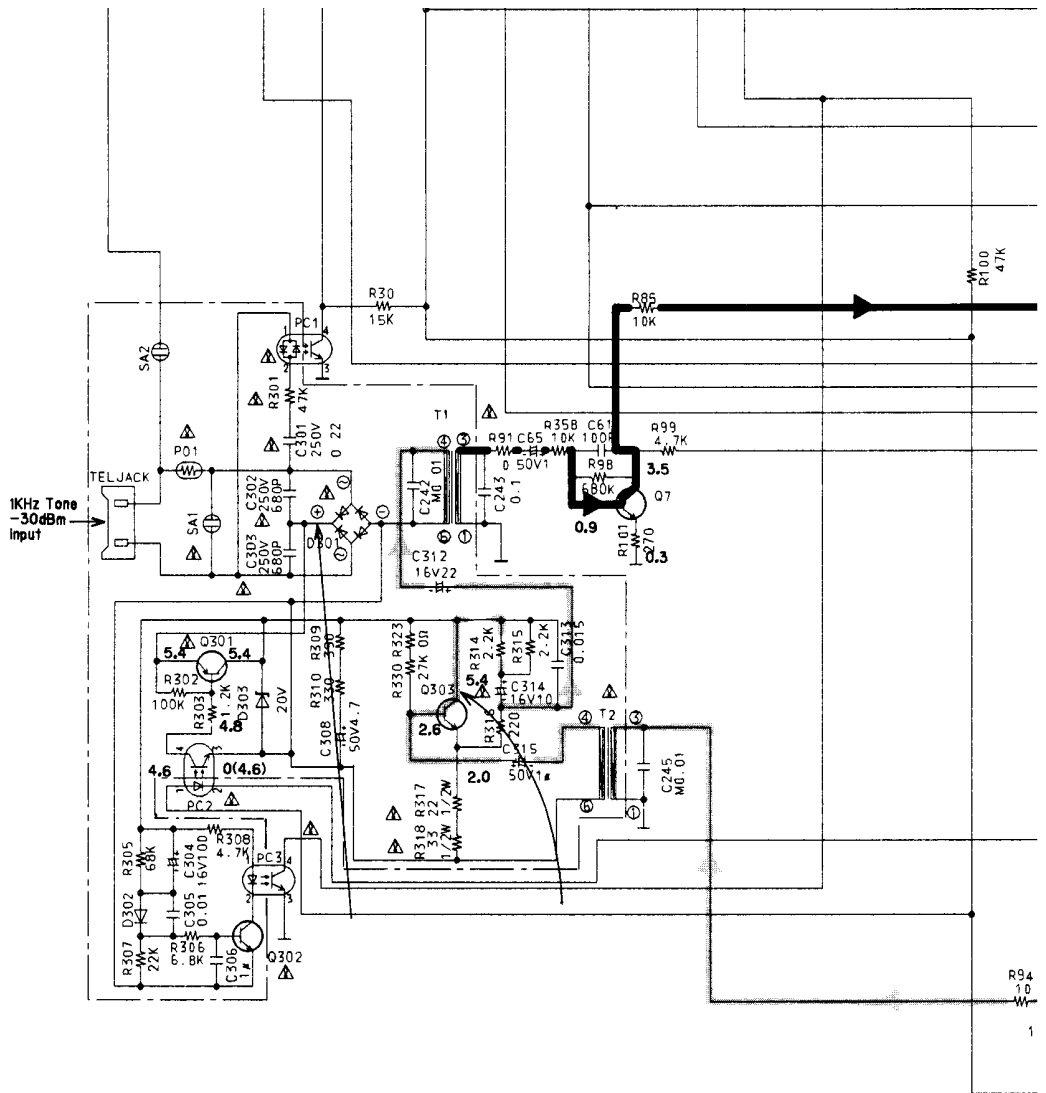

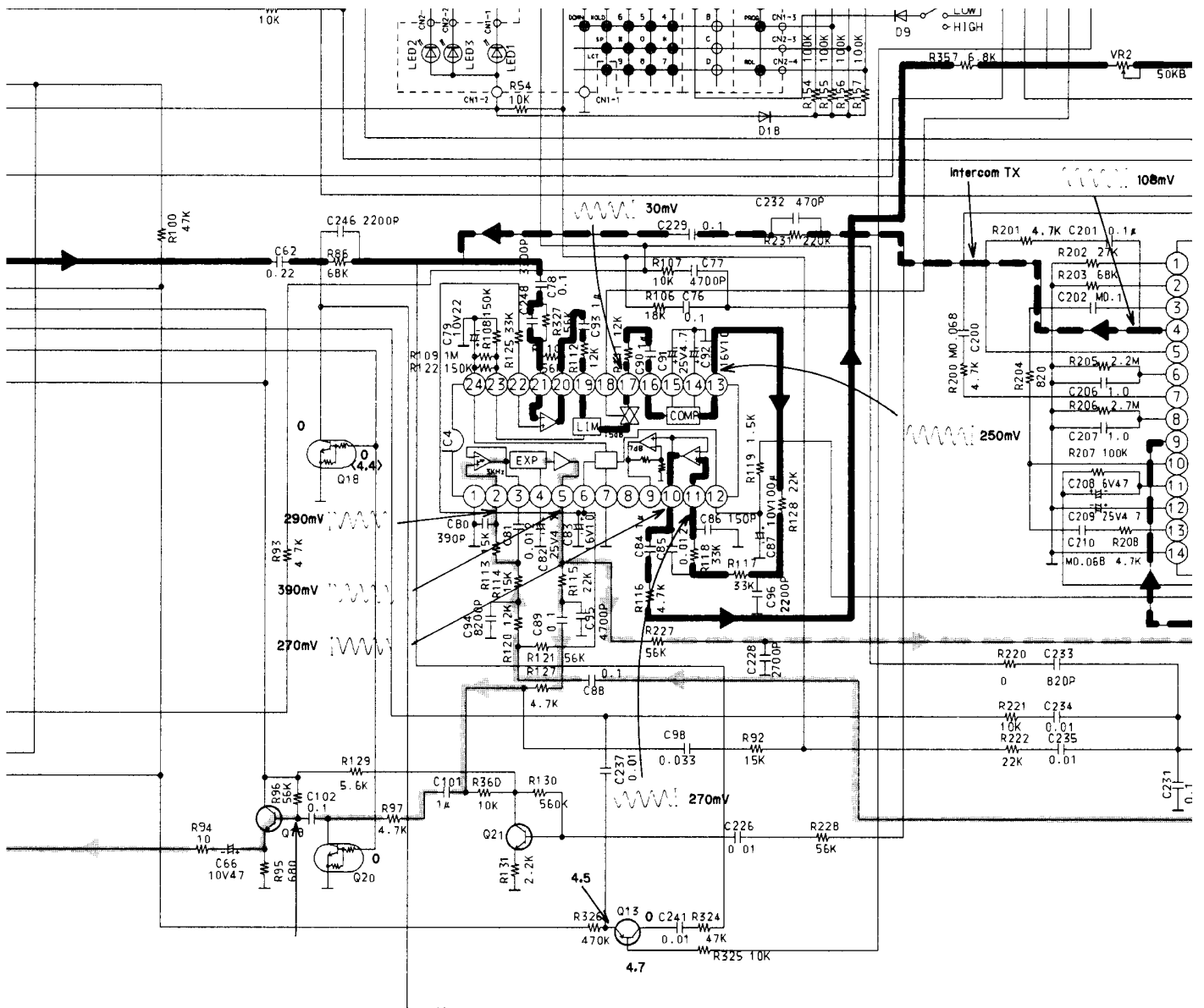

UNIT)

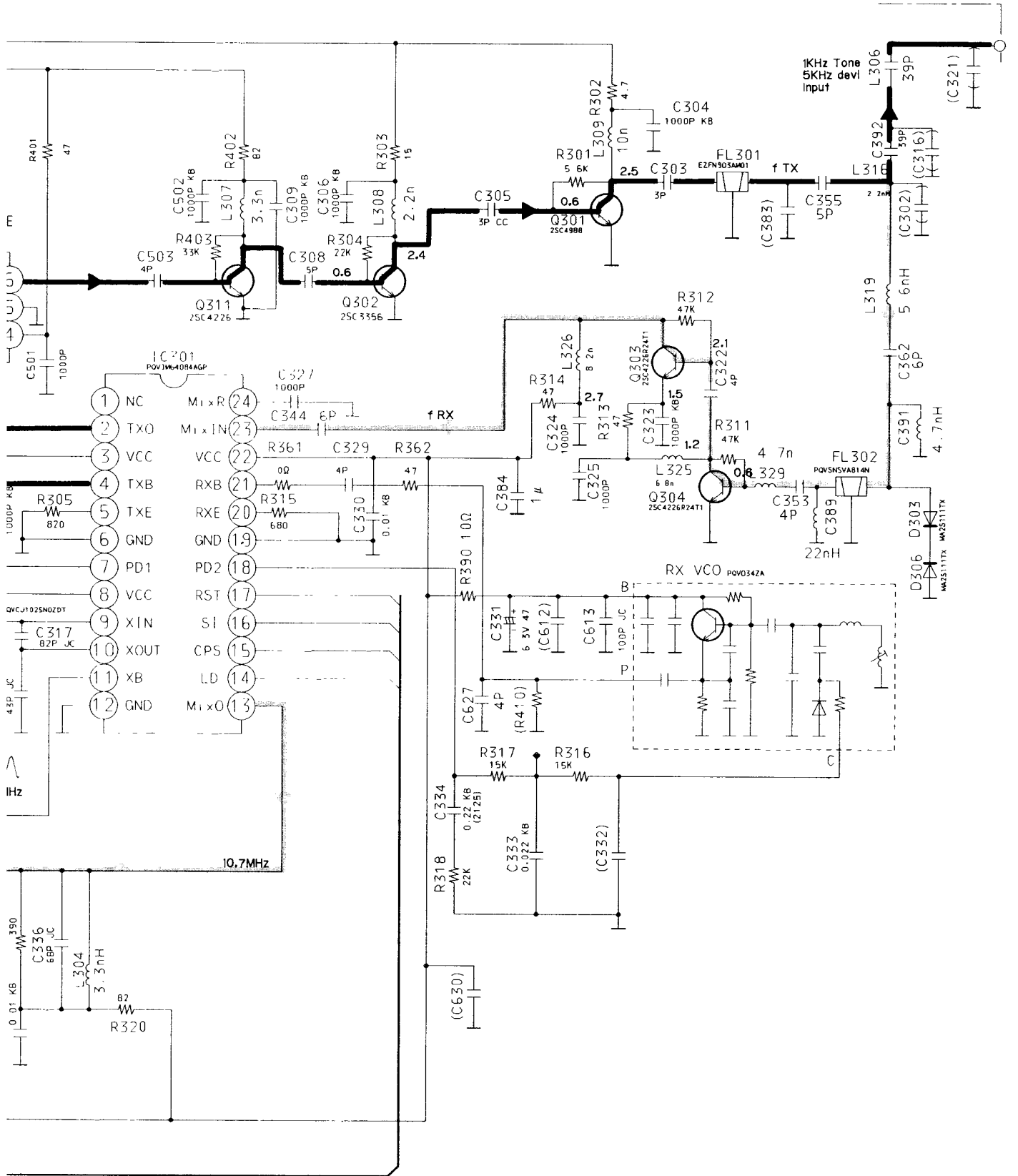

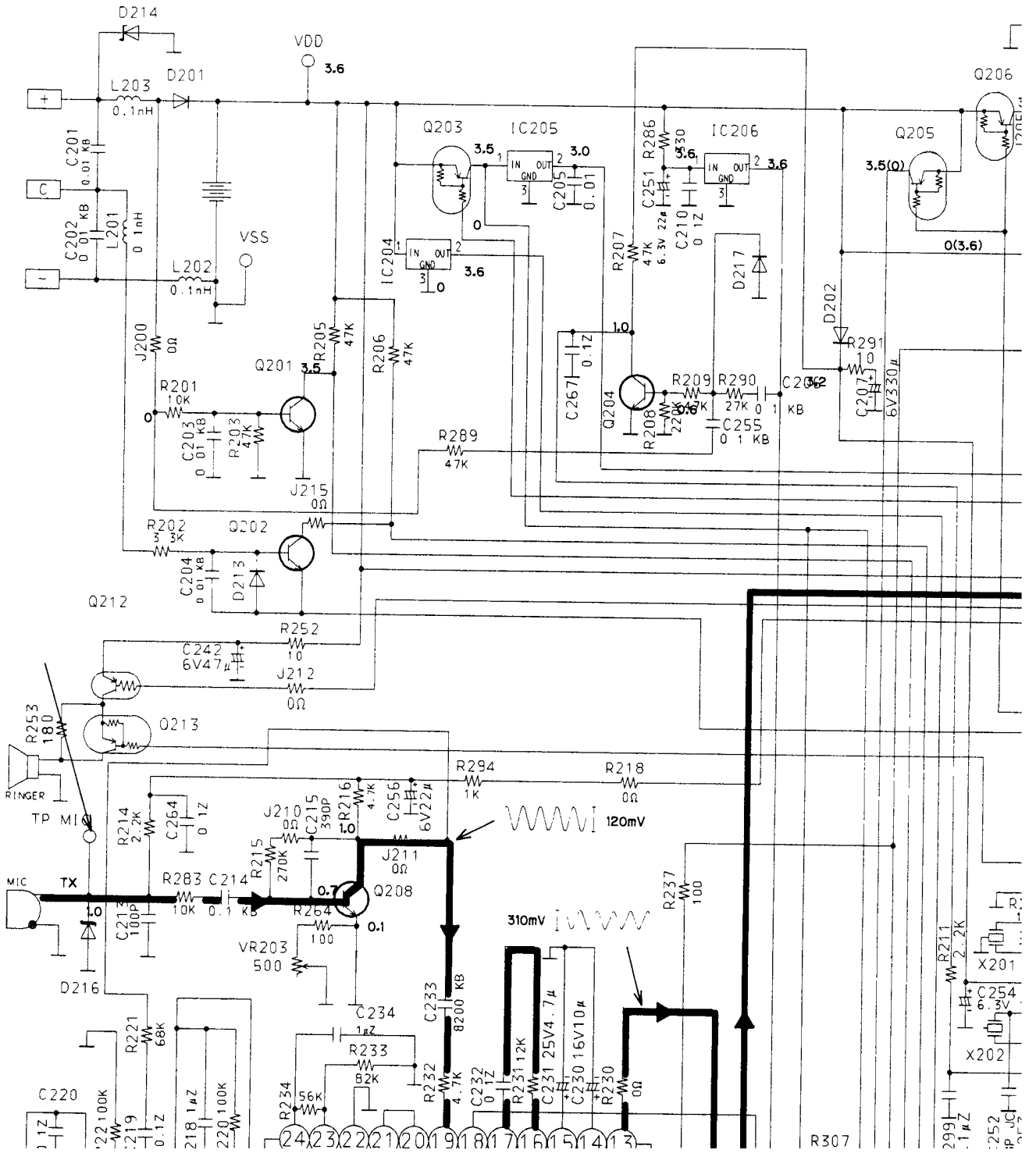

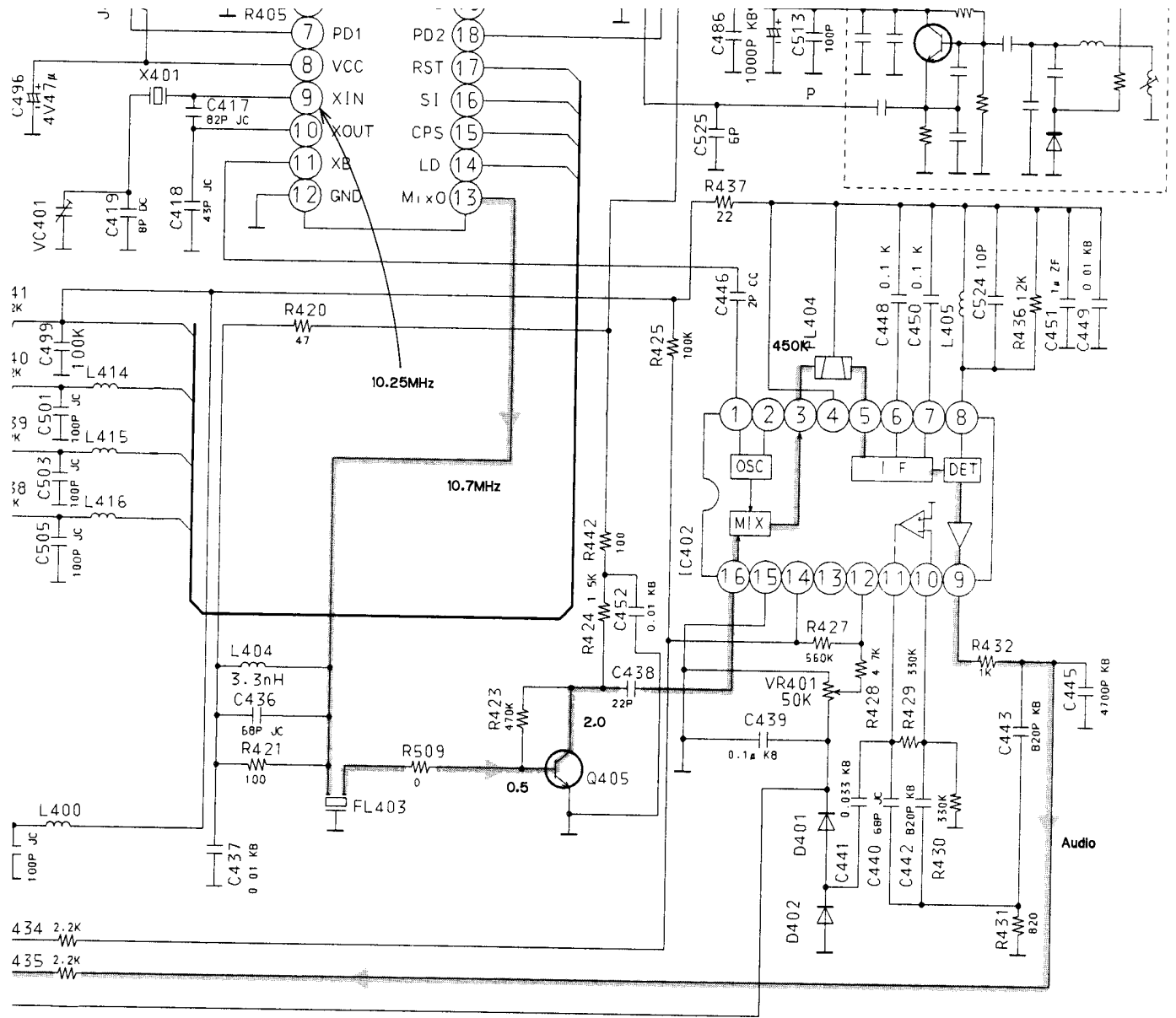

Audio

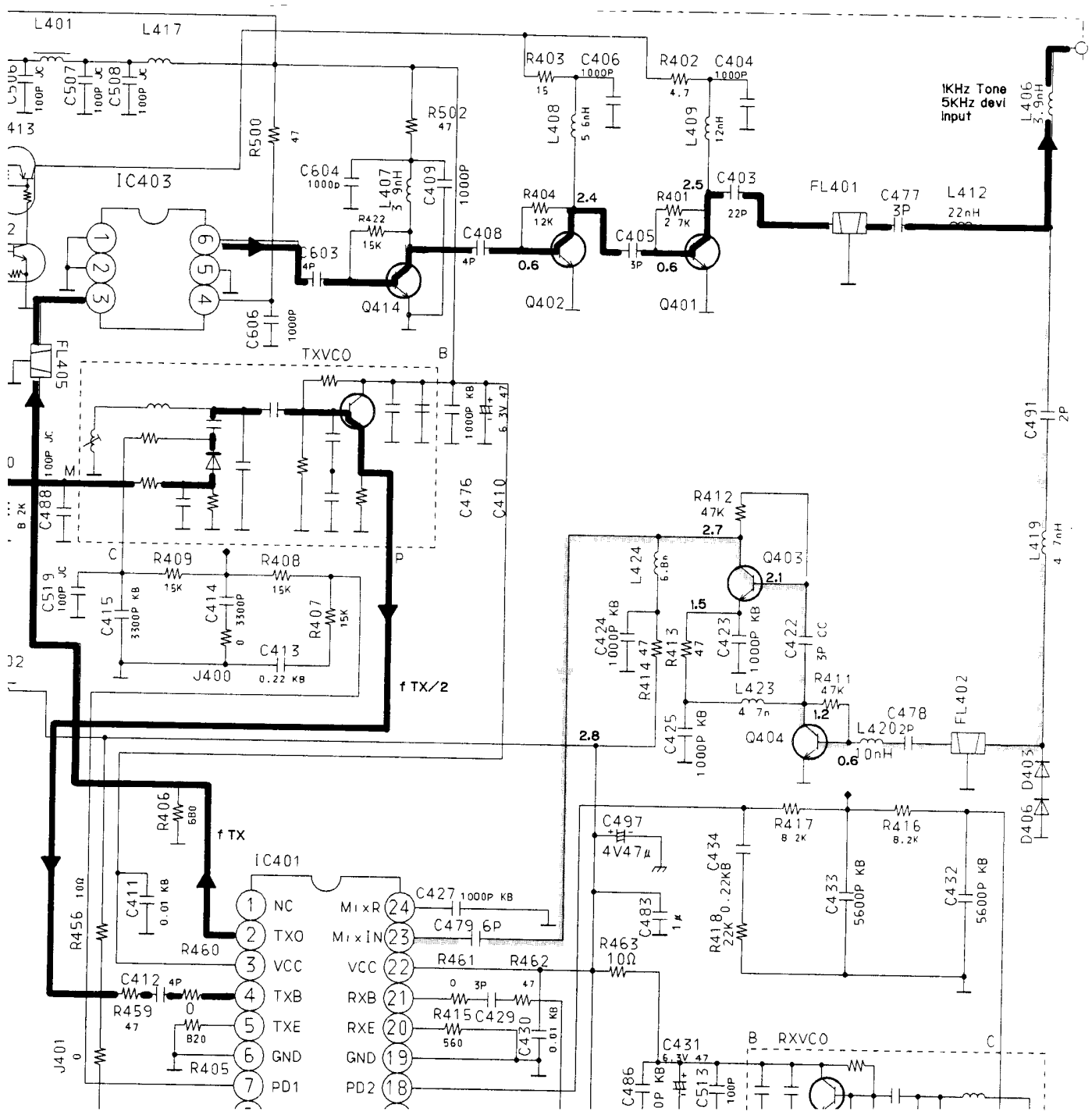

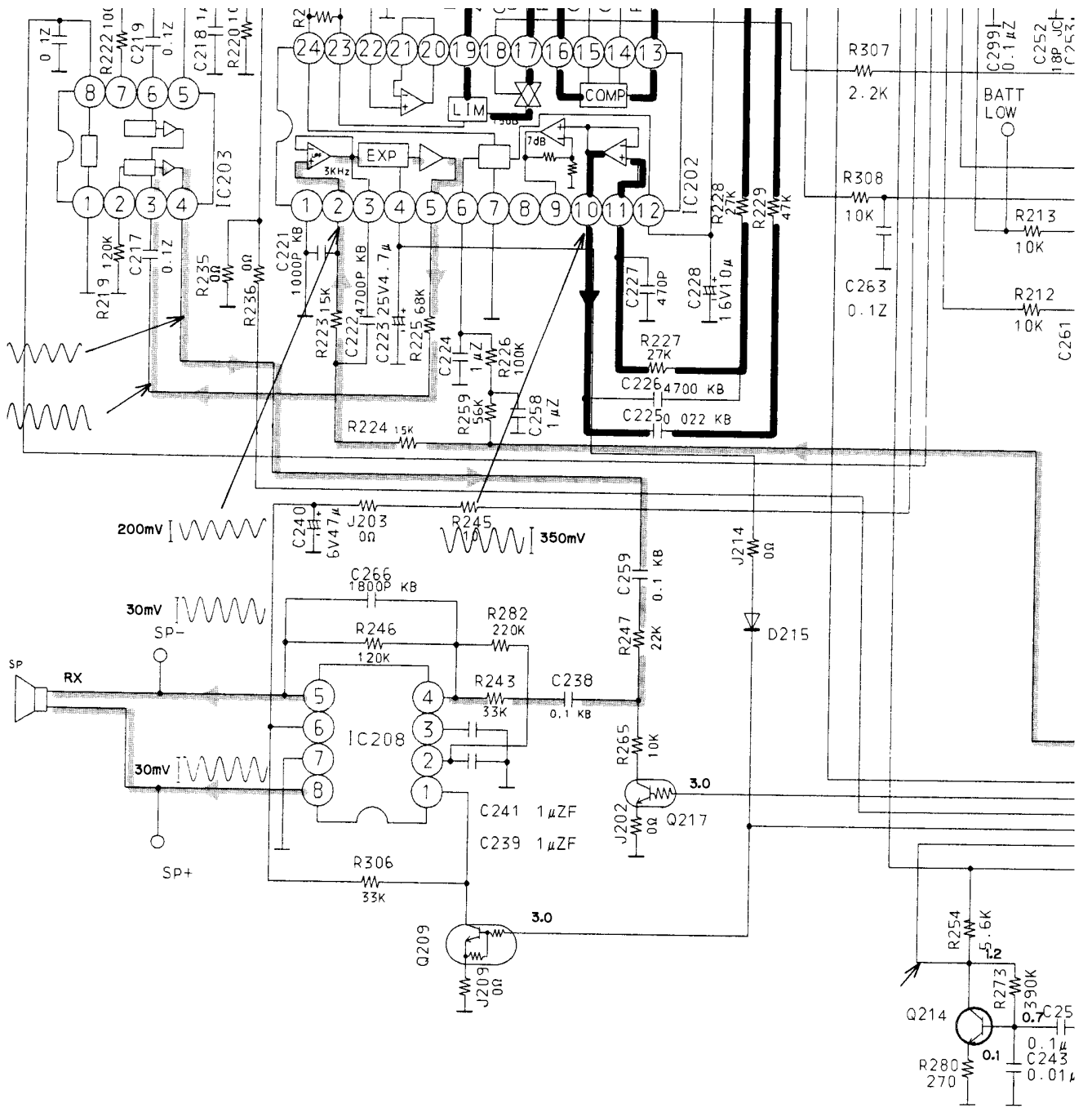

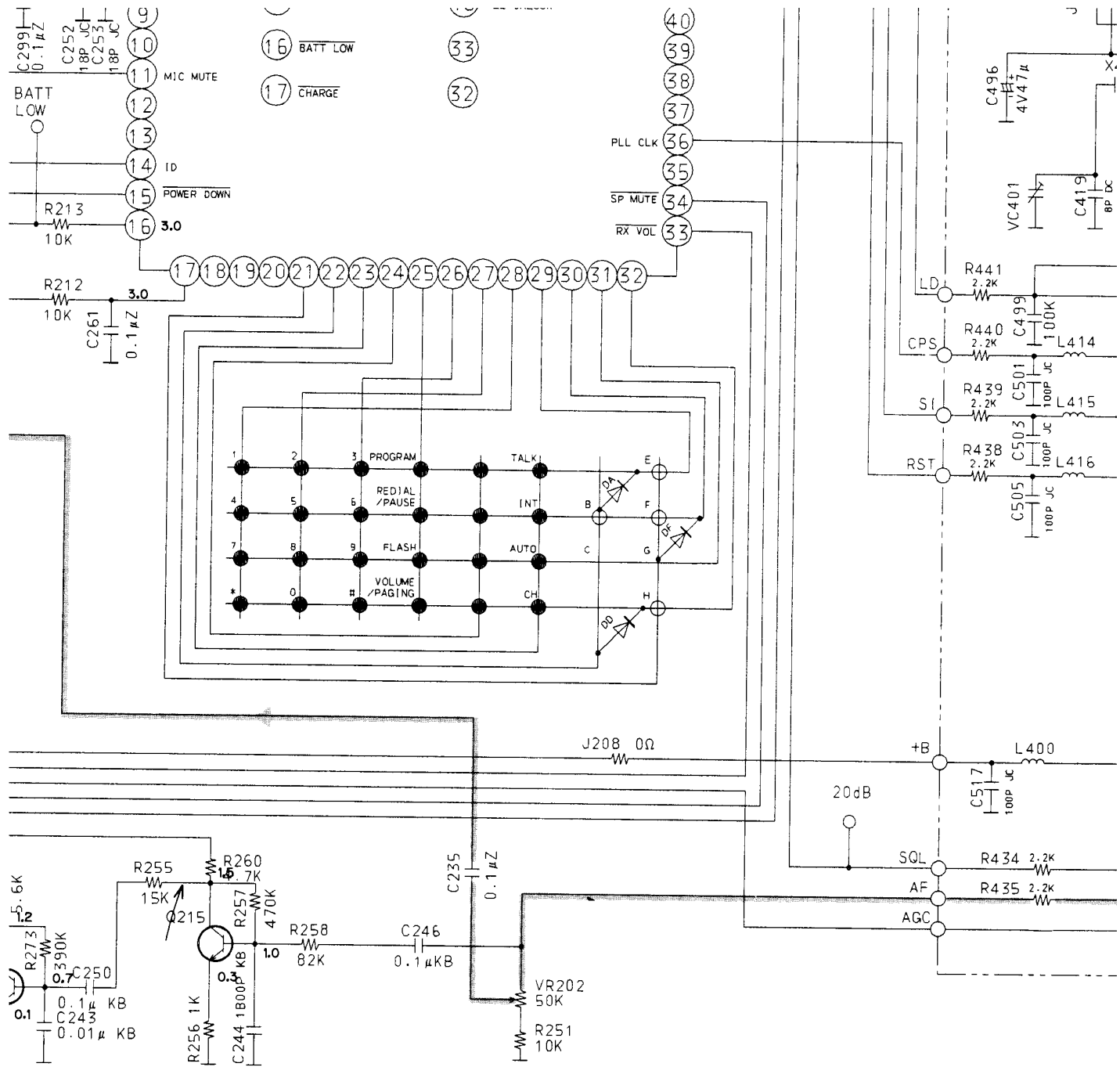

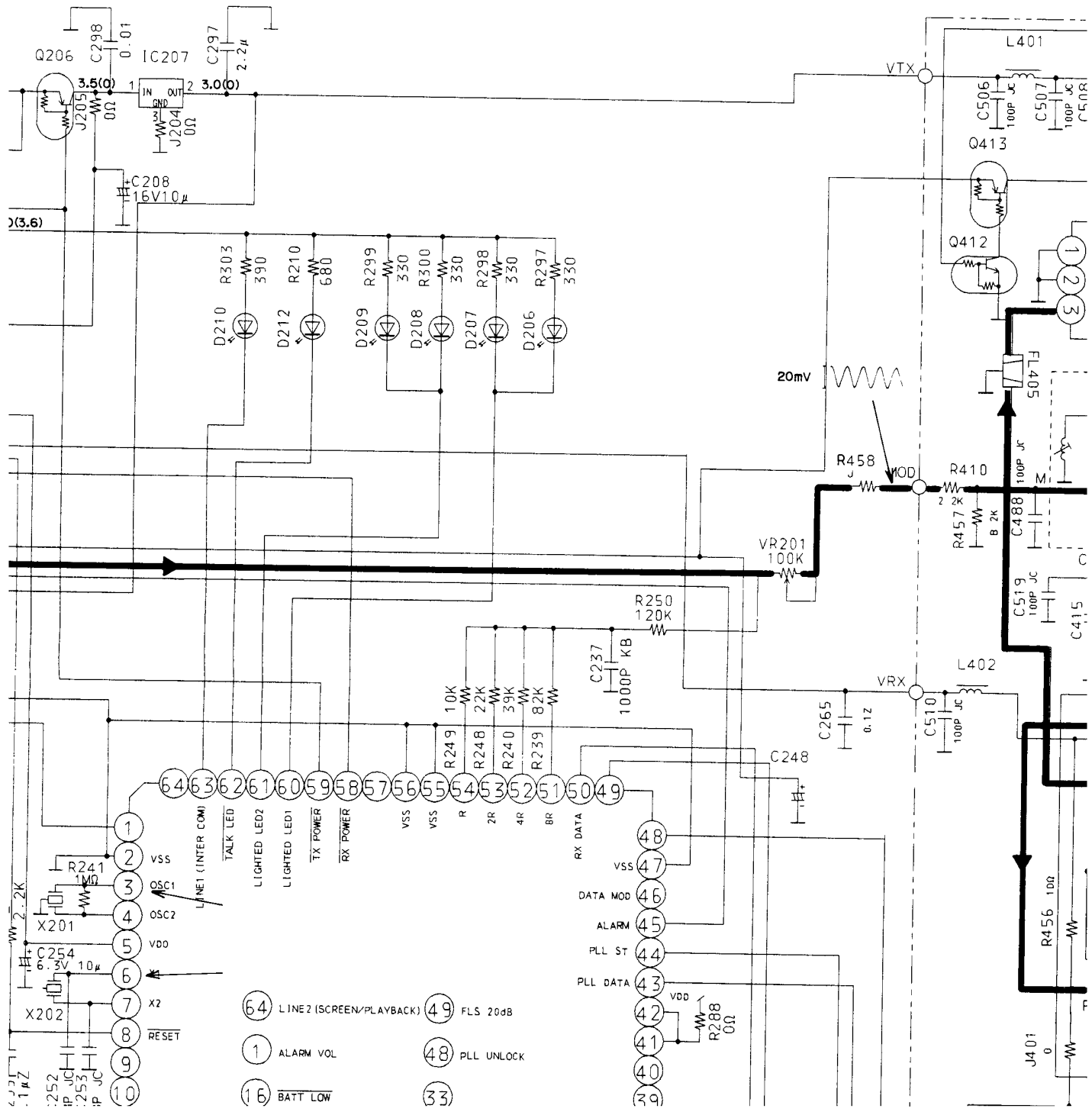

- (64) LINE2 (SCREEN/PLAYBACK)
- (49) FLS 20dB
- (1) ALARM VOL
- (48) PLL UNLOCK
- (16) BATT LOW
- (33)