

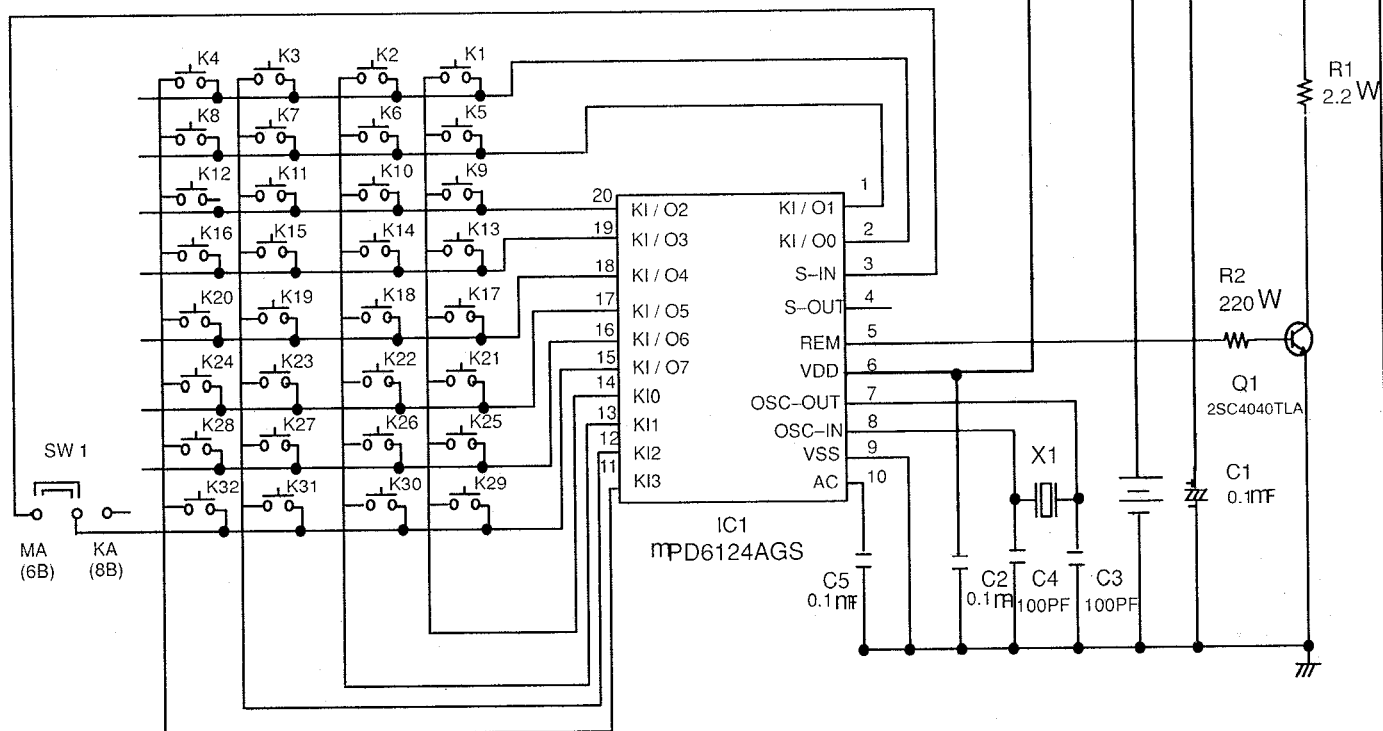











Remote Control SBAR20026A

 Shows user key



* Parts listed here are not suppliable.

Fig.26

KEY NO.	FUNCTION	DATA CODE	KEY NO.	FUNCTION	DATA CODE
1	TV/AV	05	17	—/—	3B
2	POWER	3D	18	CH 0	19
3	CH 1	10	19	NORMAL	0C
4	CH \wedge	34	20	FUNCTION	06
5	CH 3	12	21	 OFFTIMER	0F
6	CH 2	11	22	 MUTE	32
7	CH 4	13	23	 REC	08
8	CH V	35	24	 VCR	3D
9	CH 6	15	25	CH \wedge	34
10	CH 5	14	26	 F.F	03
11	CH 7	16	27	 PLAY	0A
12	 RECALL	39	28	 REW	02
13	CH 9	18	29	CH V	35
14	CH 8	17	30	 F.ADV	0C
15	VOL +	20	31	 STOP	00
16	VOL -	21	32	 PAUSE	06

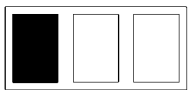
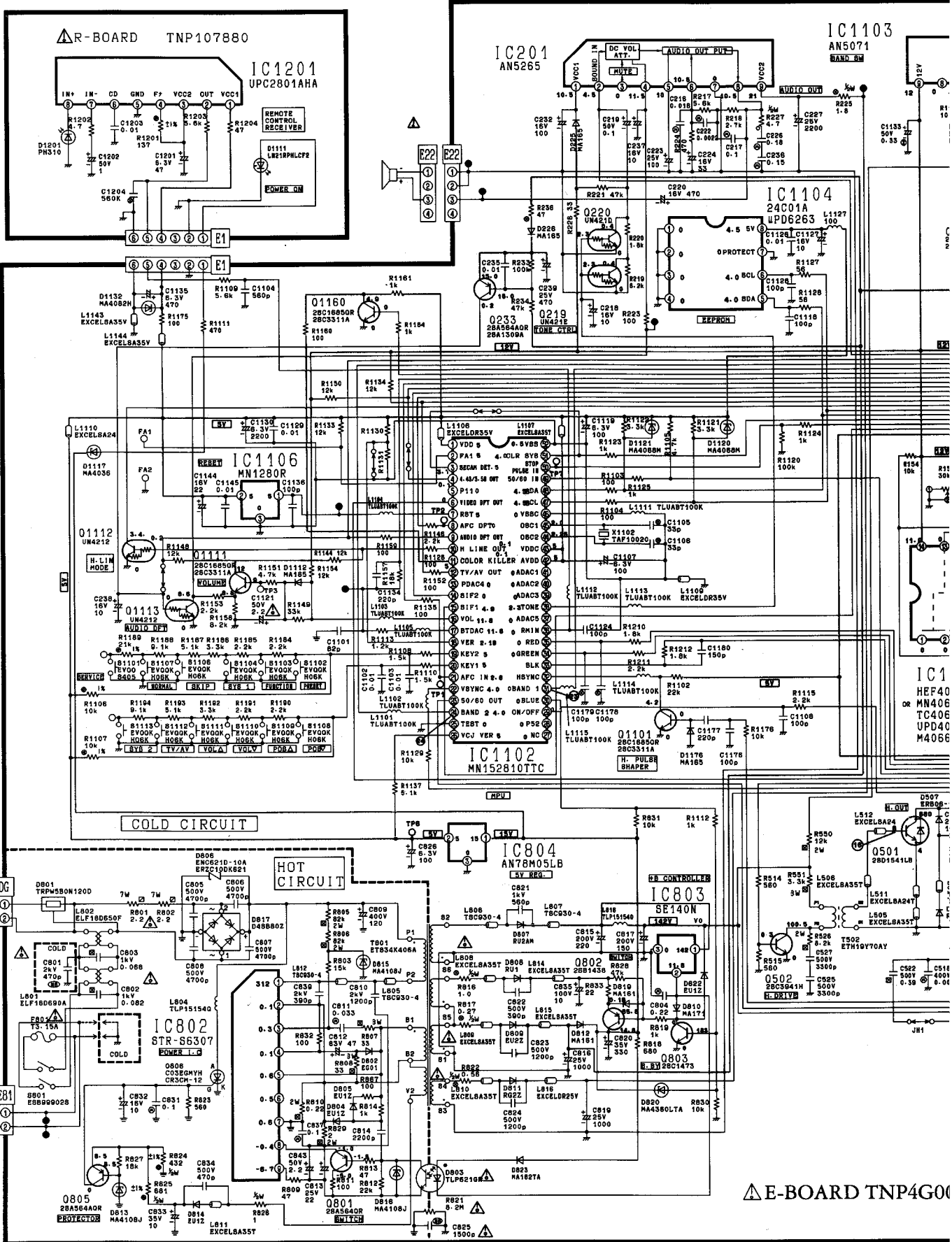

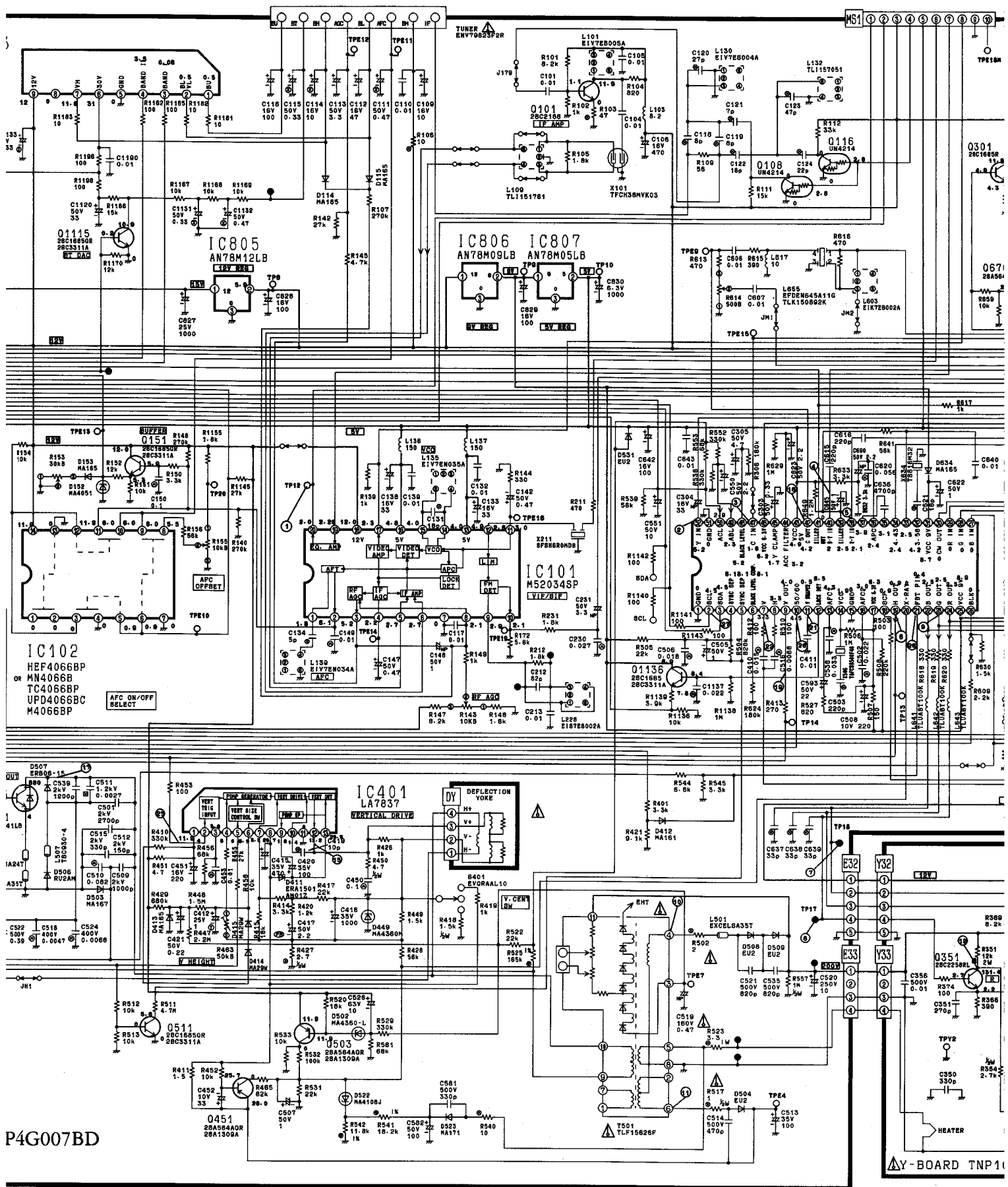

P4G007BD

Y-BOARD TNP10

