

REMOTE CONTROL TRANSMITTER EUR51246

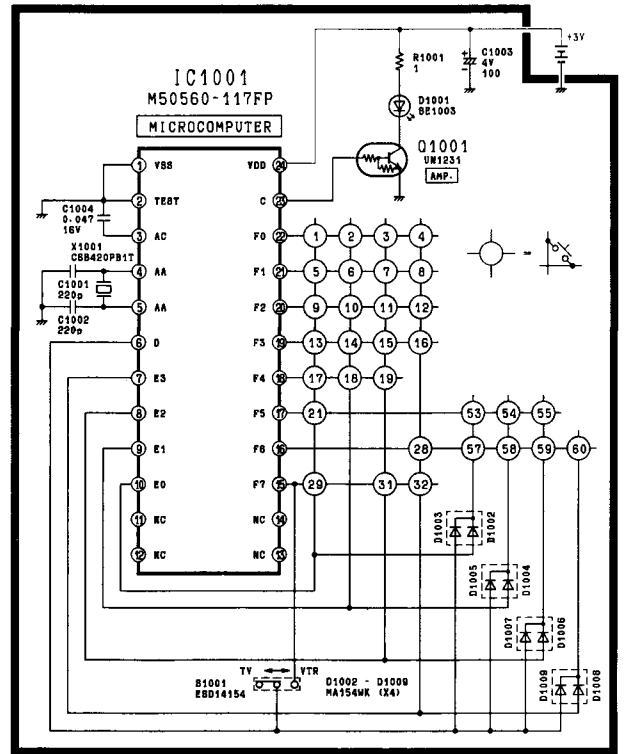

VOLTAGE TABLE (AC 120V)

Q801	Q803	Q806	Q807	Q809	Q881	Q804	Q805
C	343	4.7	32	20	344	T1	T1
B	0.1	4.1	0.5	33	28	T2	T2
E	0	0.5	0	32	32	G	G

KEY FUNCTION TABLE

REV NO.	DATA CODE	FUNCTION TV(CODE-00)	REV NO.	DATA CODE	FUNCTION TV(CODE-00)	REV NO.	DATA CODE	FUNCTION VTR(CODE-02)
1	20	POWER	13	01	VOL. UP	53	08	REC
2	10	1	14	24	---	54	08	PAUSE/STILL
3	11	2	15	19	10/0	55	0C	STILL ADV
4	12	3	16	10	TV/AV	57	00	STOP
5	22	4	17	0D	VOL. DN	58	0A	PLAY
6	15	5	18	08	MUTE	59	02	REW
7	14	5	19	07	NORMAL	60	03	FF
8	15	6	21	2D	SLEEP	---	---	---
9	23	7	28	28	RECALL	---	---	---
10	16	7	29	25	VIDED	---	---	---
11	17	8	31	2F	---	---	---	---
12	18	9	32	2E	+	---	---	---

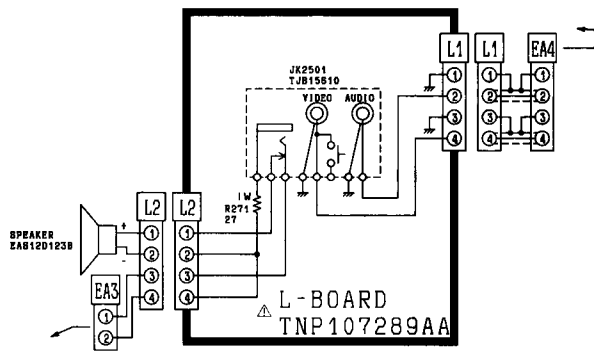

BLOCK DIAGRAM FOR IC601 (TA8653N)

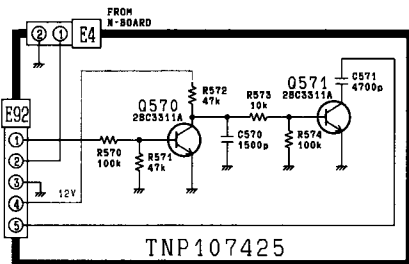
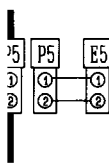
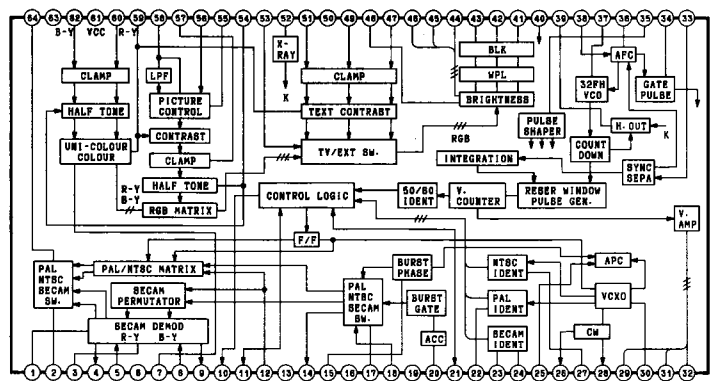

NOTE
REPLACEMENT PARTS ON THIS BOARD
ARE SHOWN ON PAGE 25.



Remote Control Receiver
TNQ2618

AERIAL BOARD
TJB172502 Δ

SWITCH FUNCTION

S1101	System I
S1102	System II
S1103	Recall
S1104	TV/AV
S1105	Normalization
S1106	Vol ▽
S1108	TUNING Auto
S1109	Skip
S1110	Preset
S1111	Prog ▽
S1112	TUNING ▽
S1113	Vol ▲
S1114	Prog ▲
S1115	TUNING ▲

VOLTAGE TABLE

IC1101

Pin No.	Voltage	Pin No.	Voltage
1	10.6	27	5.0
2	0	28	2.3
3	0	29	2.3
4	0	30	4.2
5	0.1	31	0
6	0.1	32	5.0
7	11.2	33	0
8	0.1	34	5.0
9	4.4	35	2.2
10	4.9	36	0.15
11	4.9	37	0
12	4.9	38	4.1
13	4.9	39	5.0
14	4.9	40	3.2
15	4.9	41	2.0
16	4.9	42	1.9
17	4.9	43	2.0
18	4.9	44	0
19	4.9	45	0
20	4.9	46	0
21	0.3	47	0
22	0.2	48	0
23	0.1	49	0.15
24	0.1	50	4.8
25	0	51	4.0
26	0	52	5.1

IC1104

	1	2	3	4	5	6	7	8	9
V _L	0	11.6	2.1	0	0	32.5	0	-	11.7
V _H	0	3.7	0	2.1	0	32.5	11.6	-	11.7
U	11.5	0.15	0	0	0	32.5	0	-	11.7

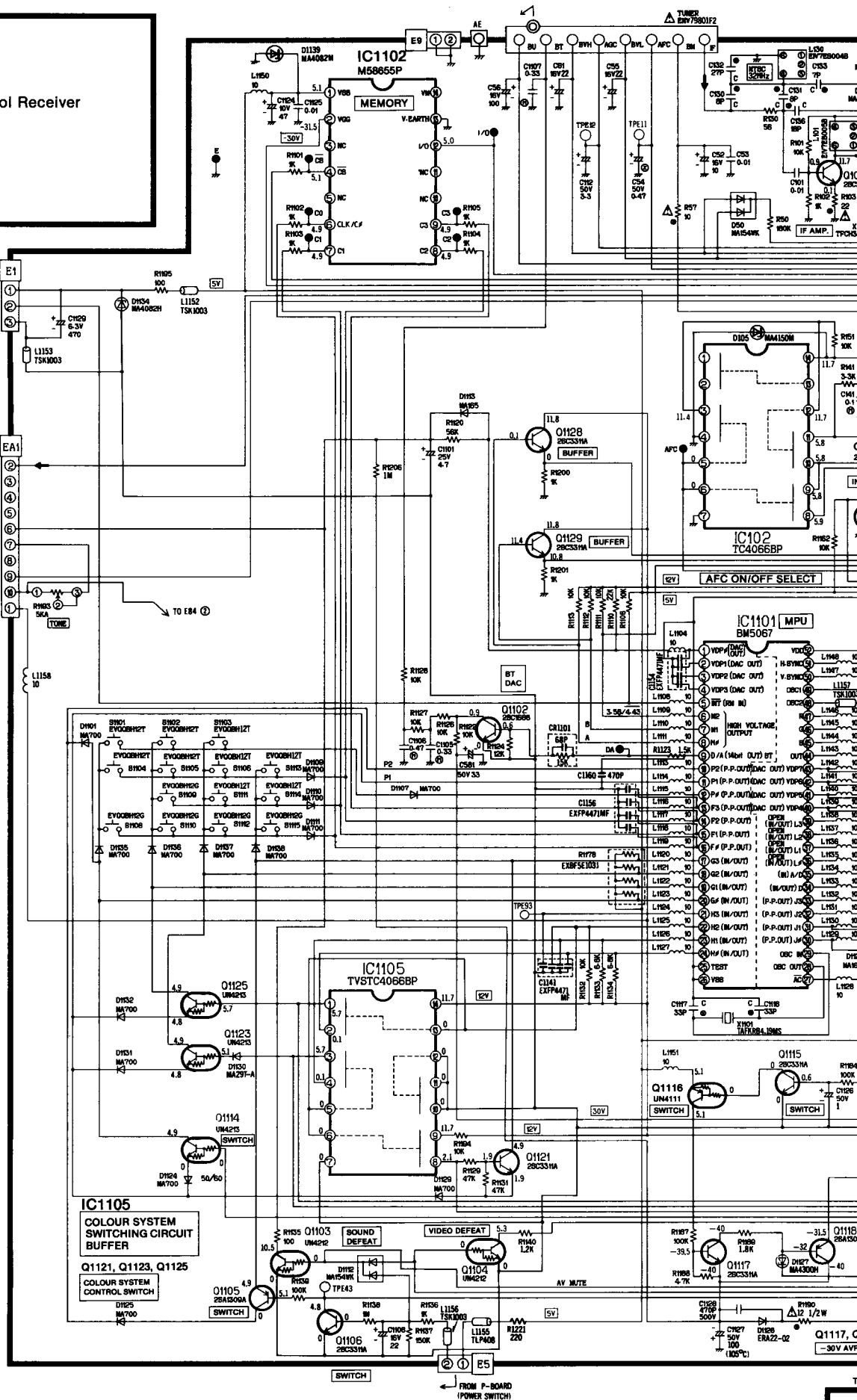

N-BOARD A
TNP107343AA

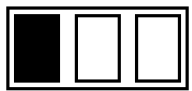

**E-BOARD
TNP197024AW**

IC601

VOLTAGE TABLE

Pin No.	64	63	62	61	60	59	58	57	56	55	54	53	52	51	50	49	48	47	46	45	44	43	42	41	40	39	38	37	36	35	34	33
Voltage	7.5	11.4	5.8	11.4	5.8	3.4	4.6	5.1	3.1	7.0	1.9	0	6.1	0	6.1	3.3	6.2	2.8	2.8	2.9	3.8	3.8	3.7	9.3	1.7	7.3	3.2	7.6	0.6	1.9	6.1	
Pin No.	1	2	3	4	5	6	7	8	9	10	11	12	13	14	15	16	17	18	19	20	21	22	23	24	25	26	27	28	29	30	31	32
Voltage	8.2	7.6	8.3	6.0	6.1	11.4	3.3	6.1	6.1	5.7	5.7	4.9	4.9	7.5	5.8	10.0	3.2	4.3	0	5.8	6.9	10.8	4.3	5.4	5.7	3.0	10.4	3.0	0.7	9.2	7.1	7.0

**Y-BOARD
TNP107244AE**

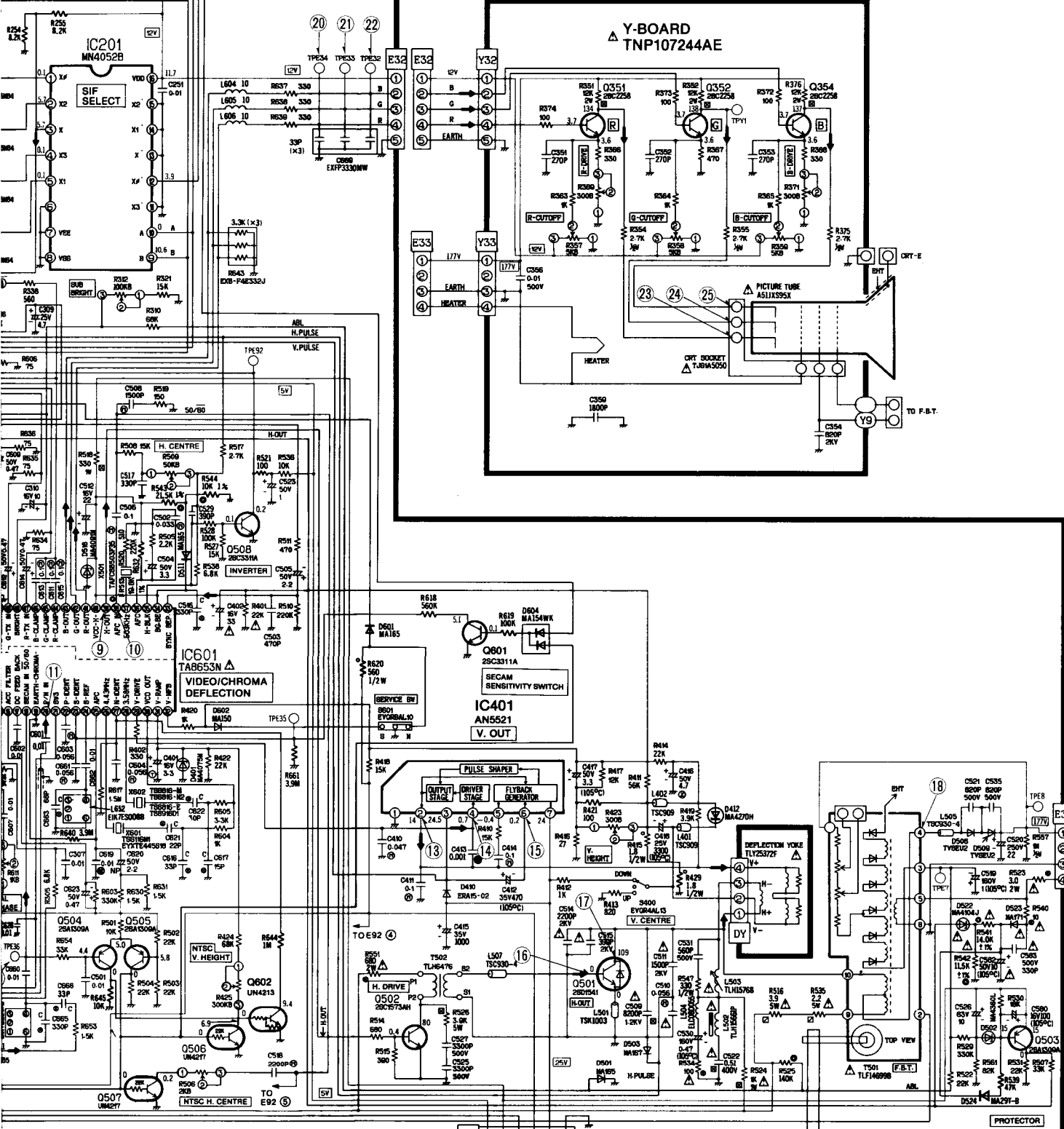

- Q504, Q505: 50/80 DISCRIMINATE BUFFER
- Q507: H. CENTRE CONTROL SWITCH
- Q506: V. HEIGHT CONTROL SWITCH
- Q602: NTSC SENSITIVITY SWITCH

- E85: 1 2 3 4 5 6
- E86: 1 2 3 4 5 6
- E87: 1 2 3 4 5 6
- TRG: 1 2 3

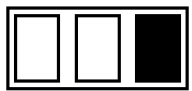

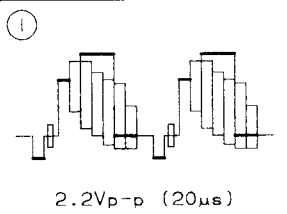
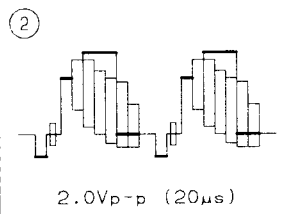
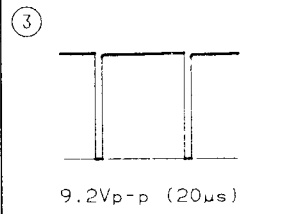
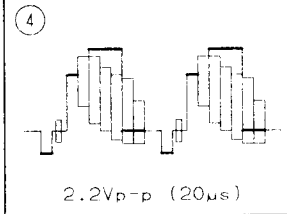
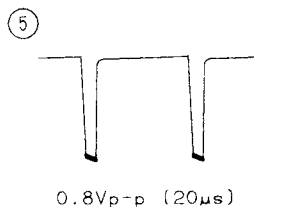
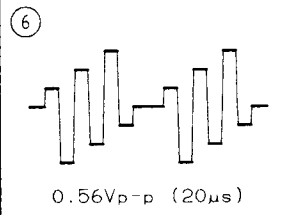
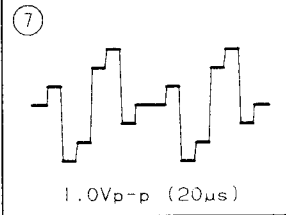
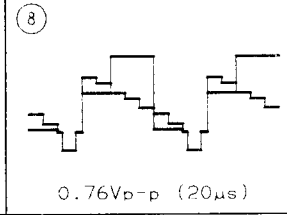
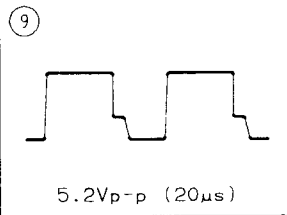
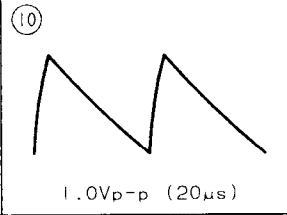
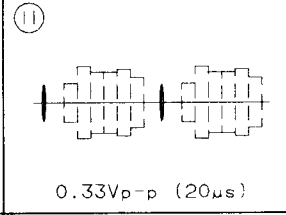
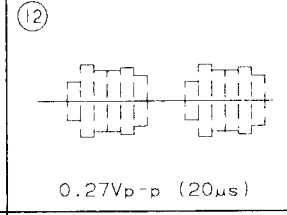
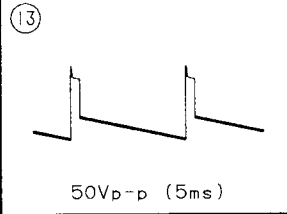
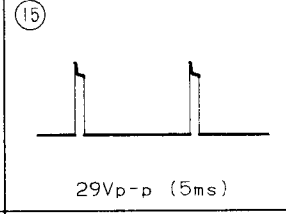
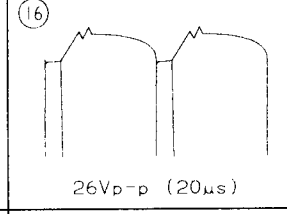
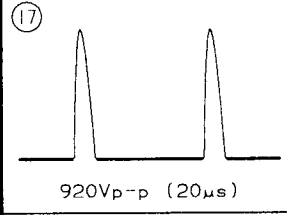
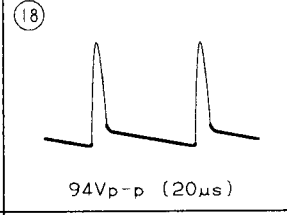
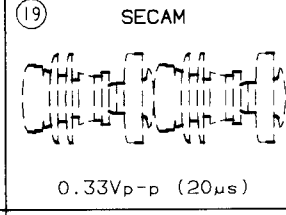
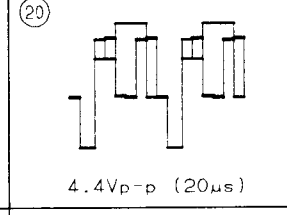
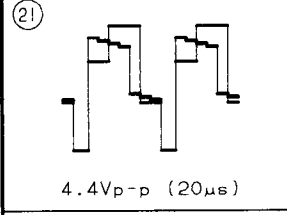
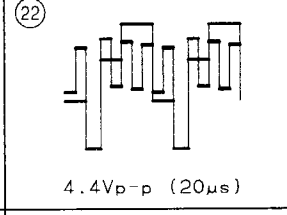
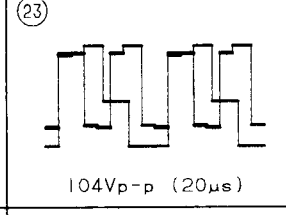
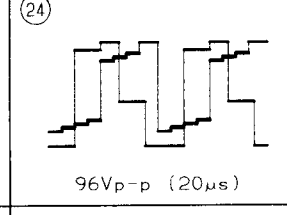
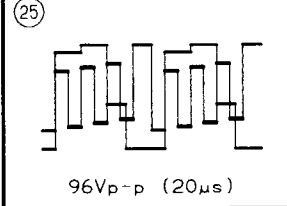
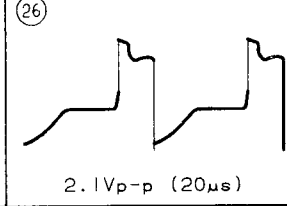
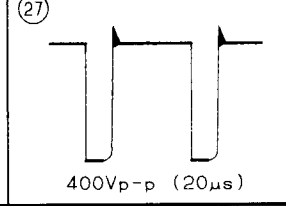
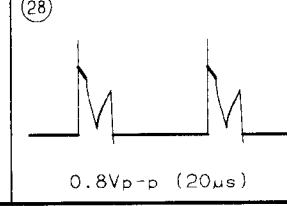

ТАБЛИЦА ИЗОБРАЖЕНИЯ ФОРМЫ ВОЛНЫ
 WAVEFORM PATTERN TABLE

 <p>2.2V_{p-p} (20µs)</p>	 <p>2.0V_{p-p} (20µs)</p>	 <p>9.2V_{p-p} (20µs)</p>	 <p>2.2V_{p-p} (20µs)</p>
 <p>0.8V_{p-p} (20µs)</p>	 <p>0.56V_{p-p} (20µs)</p>	 <p>1.0V_{p-p} (20µs)</p>	 <p>0.76V_{p-p} (20µs)</p>
 <p>5.2V_{p-p} (20µs)</p>	 <p>1.0V_{p-p} (20µs)</p>	 <p>0.33V_{p-p} (20µs)</p>	 <p>0.27V_{p-p} (20µs)</p>
 <p>50V_{p-p} (5ms)</p>	 <p>1.6V_{p-p} (5ms)</p>	 <p>29V_{p-p} (5ms)</p>	 <p>26V_{p-p} (20µs)</p>
 <p>920V_{p-p} (20µs)</p>	 <p>94V_{p-p} (20µs)</p>	 <p>SECAM 0.33V_{p-p} (20µs)</p>	 <p>4.4V_{p-p} (20µs)</p>
 <p>4.4V_{p-p} (20µs)</p>	 <p>4.4V_{p-p} (20µs)</p>	 <p>104V_{p-p} (20µs)</p>	 <p>96V_{p-p} (20µs)</p>
 <p>96V_{p-p} (20µs)</p>	 <p>2.1V_{p-p} (20µs)</p>	 <p>400V_{p-p} (20µs)</p>	 <p>0.8V_{p-p} (20µs)</p>